

Grandstream Networks, Inc.

GWN7610

Enterprise 802.11ac WiFi Access Point

User Manual



COPYRIGHT

©2017 Grandstream Networks, Inc. <http://www.grandstream.com>

All rights reserved. Information in this document is subject to change without notice. Reproduction or transmittal of the entire or any part, in any form or by any means, electronic or print, for any purpose without the express written permission of Grandstream Networks, Inc. is not permitted.

The latest electronic version of this guide is available for download here:

<http://www.grandstream.com/support>

Grandstream is a registered trademark and Grandstream logo is trademark of Grandstream Networks, Inc. in the United States, Europe and other countries.

CAUTION

Changes or modifications to this product not expressly approved by Grandstream, or operation of this product in any way other than as detailed by this guide, could void your manufacturer warranty.

WARNING

Please do not use a different power adaptor with devices as it may cause damage to the products and void the manufacturer warranty.



FCC Caution

Any Changes or modifications not expressly approved by the party responsible for compliance could void the user's authority to operate the equipment.

This device complies with part 15 of the FCC Rules. Operation is subject to the following two conditions: (1) This device may not cause harmful interference, and (2) this device must accept any interference received, including interference that may cause undesired operation.

Note: This equipment has been tested and found to comply with the limits for a Class B digital device, pursuant to part 15 of the FCC Rules. These limits are designed to provide reasonable protection against harmful interference in a residential installation. This equipment generates, uses and can radiate radio frequency energy and, if not installed and used in accordance with the instructions, may cause harmful interference to radio communications. However, there is no guarantee that interference will not occur in a particular installation. If this equipment does cause harmful interference to radio or television reception, which can be determined by turning the equipment off and on, the user is encouraged to try to correct the interference by one or more of the following measures:

- Reorient or relocate the receiving antenna.
- Increase the separation between the equipment and receiver.
- Connect the equipment into an outlet on a circuit different from that to which the receiver is connected.
- Consult the dealer or an experienced radio/TV technician for help.



GNU GPL INFORMATION

GWN7610 firmware contains third-party software licensed under the GNU General Public License (GPL). Grandstream uses software under the specific terms of the GPL. Please see the GNU General Public License (GPL) for the exact terms and conditions of the license.

Grandstream GNU GPL related source code can be downloaded from Grandstream Web site:

<http://www.grandstream.com/support/faq/gnu-general-public-license>



Table of Contents

DOCUMENT PURPOSE	10
CHANGE LOG	11
Firmware Version 1.0.2.108	11
Firmware Version 1.0.2.15	11
Firmware Version 1.0.1.27	11
WELCOME	12
PRODUCT OVERVIEW	13
Technical Specifications	13
INSTALLATION	15
Equipment Packaging	15
GWN7610 Access Point Ports	15
Power and Connect GWN7610 Access Point.....	16
Warranty.....	16
Wall and Ceiling Mount Installation.....	17
<i>Wall Mount</i>	17
<i>Ceiling Mount</i>	18
GETTING STARTED	19
LED Patterns.....	19
Discover the GWN7610	20
<i>Method 1: Discover the GWN7610 using its MAC address</i>	20
<i>Method 2: Discover the GWN7610 using GWNDiscoveryTool</i>	20
Use the Web GUI.....	21
<i>Access Web GUI</i>	21
<i>Web GUI Languages</i>	23
<i>Overview Page</i>	24
<i>Save and Apply Changes</i>	25
USING GWN7610 AS STANDALONE ACCESS POINT	26
Connect to GWN7610 Default Wi-Fi Network.....	26
USING GWN7610 AS MASTER ACCESS POINT CONTROLLER	27
Login Page.....	27
Discover and Pair Other GWN7610 Access Point.....	28



Controller Protocol Security Enhancement.....	31
NETWORK GROUPS	32
Create an SSID under a Network Group	36
Additional SSID under Same Network Group.....	37
CLIENTS CONFIGURATION	39
LED SCHEDULE	40
CAPTIVE PORTAL	42
Basic Configuration Page	42
Files Configuration Page	44
Clients Page.....	45
SYSTEM SETTINGS.....	46
Maintenance	46
<i>Basic</i>	46
<i>Upgrade</i>	46
<i>Access</i>	47
<i>Syslog</i>	47
Debug	47
<i>Capture</i>	48
<i>Core Files</i>	49
<i>Ping/Traceroute</i>	49
<i>Syslog</i>	50
UPGRADING AND PROVISIONING	51
Upgrading Firmware	51
<i>Upgrading via WEB GUI</i>	51
Upgrading Slave Access Points.....	51
Provisioning and backup.....	54
<i>Download Configuration</i>	54
<i>Upload Configuration</i>	54
<i>Configuration Server (Pending)</i>	55
Reset and reboot	55
EXPERIENCING THE GWN7610 WIRELESS ACCESS POINT	56



Table of Tables

Table 1: GWN7610 Technical Specifications	13
Table 2: GWN7610 Equipment Packaging.....	15
Table 3: GWN7610 Ports Description	15
Table 4: LED Patterns	19
Table 5: Overview.....	25
Table 6: Device Configuration	29
Table 7: Wi-Fi	32
Table 8: LED Schedule settings	40
Table 9: Basic Configuration Page	42
Table 10: Basic.....	46
Table 11: Upgrade	46
Table 12: Access	47
Table 13: Syslog.....	47
Table 14: Debug	48
Table 15: Network Upgrade Configuration	51



Table of Figures

Figure 1: GWN7610 Ports	15
Figure 2: Connecting GWN7610	16
Figure 3: Wall Mount – Steps 1 & 2	17
Figure 4: Wall Mount – Steps 3 & 4	17
Figure 5: Wall Mount – Steps 5 & 6	17
Figure 6: Ceiling Mount – Steps 1 & 2	18
Figure 7: Ceiling Mount – Step 3	18
Figure 8: Ceiling Mount – Step 4	18
Figure 9: Ceiling Mount – Steps 5 & 6	18
Figure 10: Discover the GWN7610 using its MAC Address.....	20
Figure 11: GWN Discovery Tool	21
Figure 12: GWN7610 Web GUI Login Page	22
Figure 13: Change Password on first boot.....	23
Figure 14: GWN7610 Web GUI Language – Login page	23
Figure 15: GWN7610 Web GUI Language	24
Figure 16: Overview Page.....	24
Figure 17: Apply Changes	25
Figure 18: MAC Tag Label	26
Figure 19: Login Page.....	27
Figure 20: Setup Wizard	28
Figure 21: Discover AP	28
Figure 22: Discovered Devices	29
Figure 23: GWN7610 online.....	29
Figure 24: Controller Protocol Security Enhancement.....	31
Figure 25: Network Group.....	32
Figure 26: Add a New Network Group	32
Figure 27: Device Membership	34
Figure 28: Wi-Fi Schedule.....	35
Figure 29: Add AP to Network Group from Access Points Page.....	36
Figure 30: Create an SSID.....	37
Figure 31: Additional SSID	38
Figure 32: Additional SSID Created	38
Figure 33: Clients	39
Figure 34: Ban/Unban Client.....	39
Figure 35: LEDs Schedule	41
Figure 36: Default “splash.html” page.....	44
Figure 37: Files Settings Page	45
Figure 38: Client Web Page	45



Figure 39: Capture Files.....	48
Figure 40: IP Ping	49
Figure 41: Traceroute.....	50
Figure 42: Syslog	50
Figure 43: Access Points.....	52
Figure 44: Device Configuration	53
Figure 45: GWN7610 Upgrading	53



DOCUMENT PURPOSE

This document describes how to configure the GWN7610 via Web GUI in standalone mode, with other GWN7610 as Master/Slave architecture and more. The intended audiences of this document are network administrators. Please visit <http://www.grandstream.com/support> to download the latest “GWN7610 User Manual”.

This guide covers following topics:

- [Product Overview](#)
- [Installation](#)
- [Getting Started](#)
- [Using GWN7610 as Standalone Access Point](#)
- [Using GWN7610 as Master Access Point Controller](#)
- [Network Groups](#)
- [Clients Configuration](#)
- [System Settings](#)
- [LED Schedule](#)
- [Captive Portal](#)
- [Upgrading and Provisioning](#)
- [Experiencing the GWN7610 Wireless Access Point](#)



CHANGE LOG

This section documents significant changes from previous versions of the GWN7610 user manuals. Only major new features or major document updates are listed here. Minor updates for corrections or editing are not documented here.

Firmware Version 1.0.2.108

- Controller protocol security enhancement [Controller Protocol Security Enhancement]
- LED control [LED SCHEDULE]
- Captive Portal [CAPTIVE PORTAL]
- Additional SSID [Additional SSID under Same Network Group]
- WiFi schedule [Schedule]
- Client Isolation enhancement [Client Isolation]
- Added support to store Syslog locally on the unit and display it on Web GUI [Syslog]

Firmware Version 1.0.2.15

- New Overview Page
- Web UI enhancement
- Password change on first boot [Change Password on first boot]
- Country code selection is added into setup wizard

Firmware Version 1.0.1.27

- This is the initial version



WELCOME

Thank you for purchasing Grandstream GWN7610 Enterprise Wireless Access Point. The GWN7610 is a high-performance 802.11ac wireless access point for small to medium sized businesses, multiple floor offices, commercial locations and branch offices. It offers dual-band 3x3:3 MIMO technology and a sophisticated antenna design for maximum network throughput and expanded Wi-Fi coverage range. To ensure easy installation and management, the GWN7610 uses a controller-less distributed network management design in which the controller is embedded within the product's Web user interface. This allows each access point to manage a network of up to 50 GWN7610s independently without needing separate controller hardware/software and without a single point-of-failure.

This wireless access point can be paired with any third party routers. With support for advanced QoS, low-latency real-time applications, 250+ client devices per AP and dual Gigabit network ports with PoE/PoE+, the GWN7610 is an ideal wireless access point for large and small wireless network deployments.

 **Caution:**

Changes or modifications to this product not expressly approved by Grandstream, or operation of this product in any way other than as detailed by this User Manual, could void your manufacturer warranty.



PRODUCT OVERVIEW

Technical Specifications

Table 1: GWN7610 Technical Specifications

Wi-Fi Standards	IEEE 802.11 a/b/g/n/ac
Antennas	3x 2.4 GHz, gain 3 dBi, internal antenna 3x 5 GHz, gain 3 dBi, internal antenna
Wi-Fi Data Rates	IEEE 802.11ac: 6.5 Mbps to 1300 Mbps IEEE 802.11a: 6, 9, 12, 18, 24, 36, 48, 54 Mbps IEEE 802.11n: 6.5 Mbps to 450 Mbps IEEE 802.11b: 1, 2, 5.5, 11 Mbps IEEE 802.11g: 6, 9, 12, 18, 24, 36, 48, 54 Mbps *Actual throughput may vary depending on many factors including environmental conditions, distance between devices, radio interference in the operating environment and mix of devices in the network.
Frequency Bands	2.4GHz radio: 2.400 - 2.4835 GHz 5GHz radio: 5.150 - 5.250 GHz, 5.725 - 5.850 GHz (FCC, IC, RCM)
Channel Bandwidth	2.4G: 20 and 40 MHz 5G: 20,40 and 80 MHz
Wi-Fi Security	WEP, WPA/WPA2-PSK, WPA/WPA2-Enterprise (TKIP/AES)
MIMO	3x3:3 2.4GHz, 3x3:3 5GHz
Coverage Range	575ft. (175 meters) *Coverage range can vary based on environment
Maximum TX Power	5G: 26dBm 2.4G: 26dBm *Maximum power varies by country, frequency band and MCS rate.
Receiver Sensitivity	2.4G 802.11b:-92dBm@11Mbps; 802.11g:-76dBm@54Mbps; 802.11n 20MHz: -73dBm@MCS7; 802.11n 40MHz:-70dBm@MCS7 5G 802.11a:-94dBm@6Mbps; 801.11a:-77dBm@54Mbps; 802.11ac 20MHz: -69dBm@MCS8; 802.11ac HT40:-65dBm@MCS9; 802.11ac 80MHz:- 61dBm@MCS9



BSSID	16 BSSID per AP
Concurrent Clients	250+
Network Interfaces	2x autosensing 10/100/1000 Base-T Ethernet Ports
Auxiliary Ports	1x USB 2.0 port, 1x Reset Pinhole, 1x Kensington lock
Mounting	Indoor wall mount or ceiling mount, kits included
LEDs	3 tri-color LEDs for device tracking and status indication
Network Protocols	IPv4, 802.1Q, 802.1p, 802.1x, 802.11e/WMM
QoS	802.11e/WMM, VLAN, TOS
Network Management	Embedded controller in GWN7610 allows it to auto-discover, auto-provision and manage up to 50 GWN7610s in a network
Auto Power Saving	Self-power adaptation upon auto detection of PoE or PoE+
Power and Green Energy Efficiency	DC Input: 24VDC/1A Power over Ethernet 802.3af/802.3at compliant Maximum Power Consumption: 13.8W
Temperature & Humidity	Operation: 0°C to 50°C Storage: -10°C to 60°C Humidity: 10% to 90% Non-condensing
Physical	Unit Dimension: 205.3 x 205.3 x 45.9mm; Unit Weight: 540g Unit + Mounting Kits Dimension: 205.3 x 205.3 x 50.9mm; Unit + Mounting Kits Weight: 600g Entire Package Dimension: 258 x 247 x 86mm; Entire Package Weight: 900g
Package Content	GWN7610 802.11ac Wireless AP, Mounting Kits, Quick Installation Guide
Compliance	FCC, CE, RCM, IC



INSTALLATION

Before deploying and configuring the GWN7610, the device needs to be properly powered up and connected to the network. This section describes detailed information on installation, connection and warranty policy of the GWN7610.

Equipment Packaging

Table 2: GWN7610 Equipment Packaging

Main Case	Yes (1)
Mounting Bracket	Yes (1)
Ceiling Mounting Bracket	Yes (1)
Plastic Expansion Bolt	Yes (3)
M3 NUT	Yes (3)
Screw (PM 3 x 50)	Yes (3)
Screw (PM 3.5 x 20)	Yes (3)
Quick Installation Guide	Yes (1)
GPL License	Yes (1)

GWN7610 Access Point Ports



Figure 1: GWN7610 Ports

Table 3: GWN7610 Ports Description

Port	Description
Power	Power adapter connector (24V, 1A)
NET/POE	Ethernet RJ45 port (10/100/1000Mbps) supporting PoE/PoE+ (802.3af/802.3at).
NET	Ethernet RJ45 port (10/100/1000Mbps) to your router or another GWN76xx series
	USB 2.0 port (for future IOT & location based applications)
RESET	Factory reset button. Press for 7 seconds to reset factory default settings.



Power and Connect GWN7610 Access Point

Step 1:

Connect one end of a RJ-45 Ethernet cable into the NET or PoE/NET port of the GWN7610.

Step 2:

Connect the other end of the Ethernet cable(s) into a LAN port to your Network.

Step 3:

Connect the 24V DC power adapter into the power jack on the back of the GWN7610. Insert the main plug of the power adapter into a surge-protected power outlet.

Notes:

- GWN7610 can be powered using PoE(802.3af)/PoE+(802.3at) switch via PoE/NET port. In this scenario, GWN7610 should be connected to the Router using NET port.
- GWN7610 has a PoE detection daemon that will monitor the status and update maximum allowable power for USB ports in real time.

Step 4:

Wait for the GWN7610 to boot up and acquire an IP address from the DHCP Server.

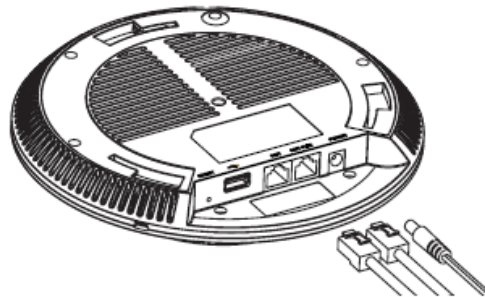

Figure 2: Connecting GWN7610

Warranty

If the GWN7610 Wireless Access Point was purchased from a reseller, please contact the company where the device was purchased for replacement, repair or refund. If the device was purchased directly from Grandstream, contact our Technical Support Team for a RMA (Return Materials Authorization) number before the product is returned. Grandstream reserves the right to remedy warranty policy without prior notification.

Wall and Ceiling Mount Installation

GWN7610 can be mounted on the wall or ceiling, please refer to the following steps for the appropriate installation.

Wall Mount

Step 1:

Position the mounting bracket at the desired location on the wall with the arrow pointing up.

Step 2:

Use a pencil to mark the four mounting holes (screw holes DIA 5.5mm, reticle hole DIA 25mm).

Step 3:

Insert screw anchors into the 5.5 mm holes. Attach the mounting bracket to the wall by inserting the screws into the anchors.

Step 4:

Connect the power cable and the Ethernet cable (RJ45) to the correct ports of your GWN7610.

Step 5:

Align the arrow on the GWN7610AP with the arrow on the locking tab of the mounting bracket and ensure that your GWN is firmly seated on the mounting bracket.

Step 6:

Turn the GWN clockwise until it locks into place and fits the locking tab.

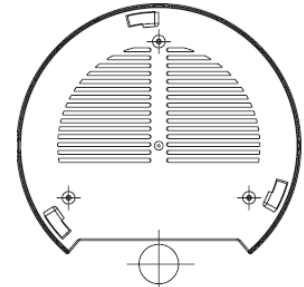

Figure 3: Wall Mount – Steps 1 & 2

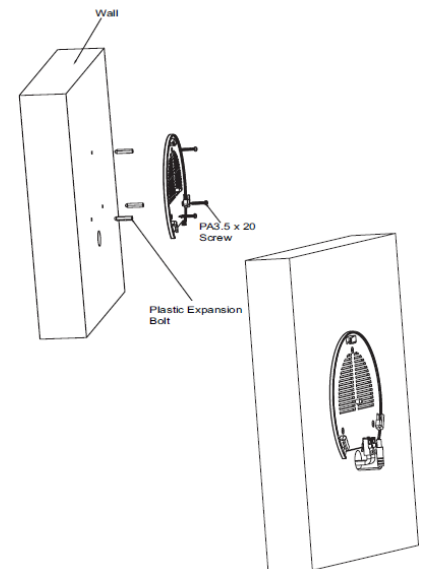

Figure 4: Wall Mount – Steps 3 & 4

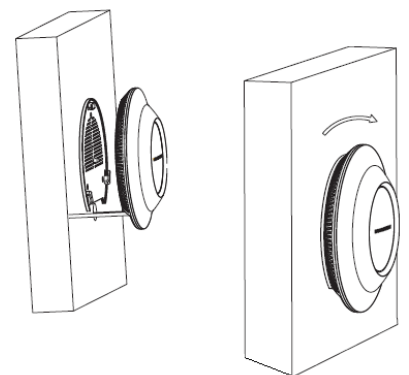

Figure 5: Wall Mount – Steps 5 & 6



Ceiling Mount

Step 1:

Remove the ceiling tile.

Step 2:

Place the ceiling backing plate in the center of the ceiling tile and mark the mounting screw holes (screw holes DIA 5.5mm, reticle hole DIA 25mm).

Step 3:

Insert the screws through the mounting bracket.

Step 4:

Connect the power cable and the Ethernet cable (RJ45) to the correct ports of your GWN7610.

Step 5:

Align the arrow on the GWN7610AP with the arrow on the locking tab of the mounting bracket and ensure that your GWN is firmly seated on the mounting bracket and connect the network and power cables.

Step 6:

Turn the GWN clockwise until it locks into place and fits the locking tab.



Note:

Ceiling mounting is recommended for optimal coverage performance.

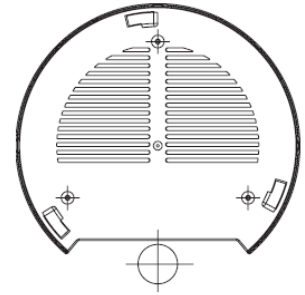

Figure 6: Ceiling Mount – Steps 1 & 2

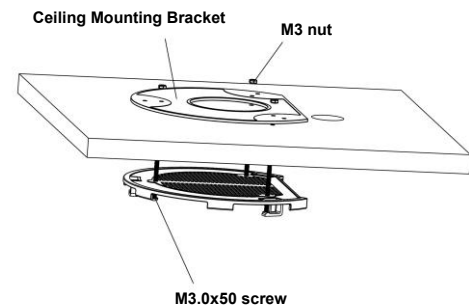

Figure 7: Ceiling Mount – Step 3

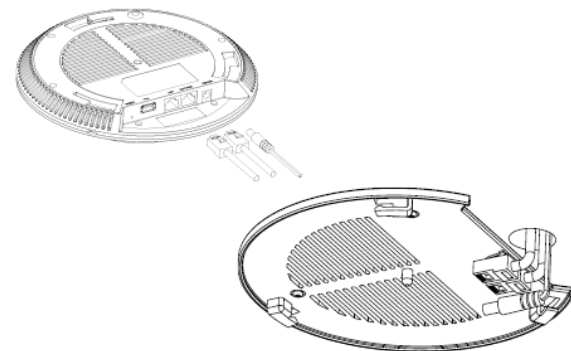

Figure 8: Ceiling Mount – Step 4

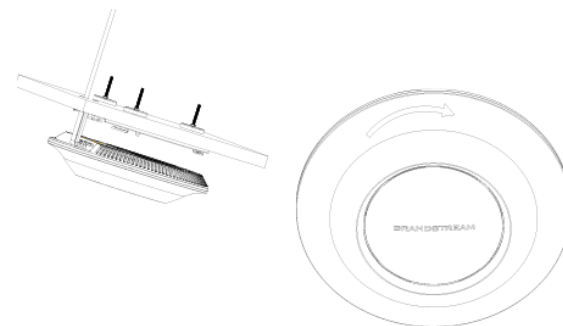

Figure 9: Ceiling Mount – Steps 5 & 6



GETTING STARTED

The GWN7610 Wireless Access Point provides an intuitive Web GUI configuration interface for easy management to give users access to all the configurations and options for the GWN7610's setup.

This section provides step-by-step instructions on how to read LED patterns, discover the GWN7610 and use its Web GUI interface.

LED Patterns

The panel of the GWN7610 has different LED patterns for different activities, to help users read the status of the GWN7610 whether it's powered up correctly, provisioned, in upgrading process and more, for more details please refer to the below table.

Table 4: LED Patterns

LED Status	Indication
OFF	Unit is powered off or abnormal power supply.
Solid green	Unit is powered on.
Blinking green	Firmware update in progress.
Solid green	Firmware update is successful.
Solid red	Firmware update failed.
Blinking purple	Unit not provisioned.
Blinking blue	Unit provisioning in progress.
Solid blue	Unit is provisioned successfully.



Discover the GWN7610

Once the GWN7610 is powered up and connected to the Network correctly, users can discover the GWN7610 using one of the below methods:

Method 1: Discover the GWN7610 using its MAC address

1. Locate the MAC address on the MAC tag of the unit, which is on the underside of the device, or on the package.
2. From a computer connected to same Network as the GWN7610, type in the following address using the GWN7610's MAC address on your browser https://gwn_<mac>.local

For example, if a GWN7610 has the MAC address **00:0B:82:8B:4E:28**, this unit can be accessed by typing https://gwn_000b828b4e28.local/ on the browser.

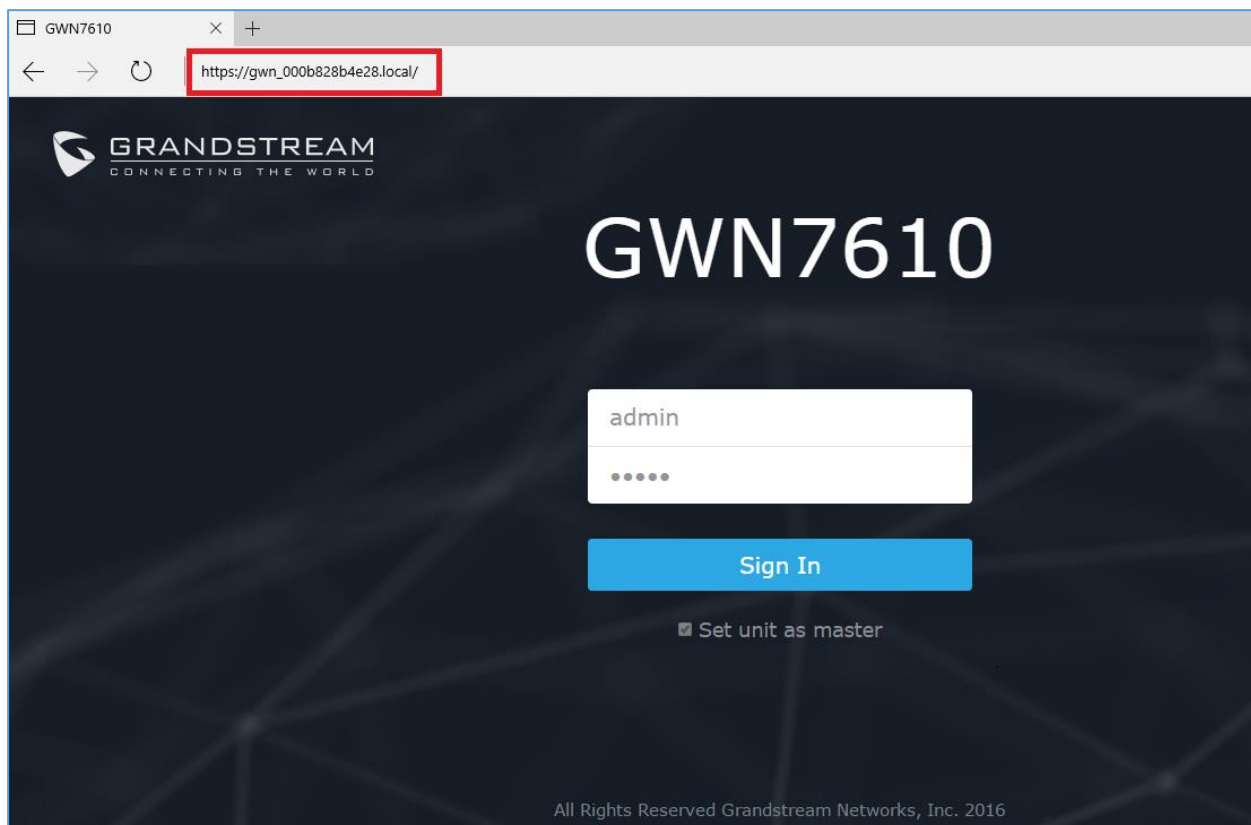

Figure 10: Discover the GWN7610 using its MAC Address

Method 2: Discover the GWN7610 using GWNDiscoveryTool

1. Download and install **GWNDiscoveryTool** from the following link:
<http://www.grandstream.com/sites/default/files/Resources/GWNDiscoveryTool.zip>
2. Open the GWNDiscoveryTool, click on **Select** to define the network interface, then click on **Scan**.



3. The tool will discover all GWN7610 Access Points connected on the network showing their MAC, IP addresses and firmware version.
4. Click on **Manage Device** to be redirected directly to the GWN7610's configuration interface, or type in manually the displayed IP address on your browser.

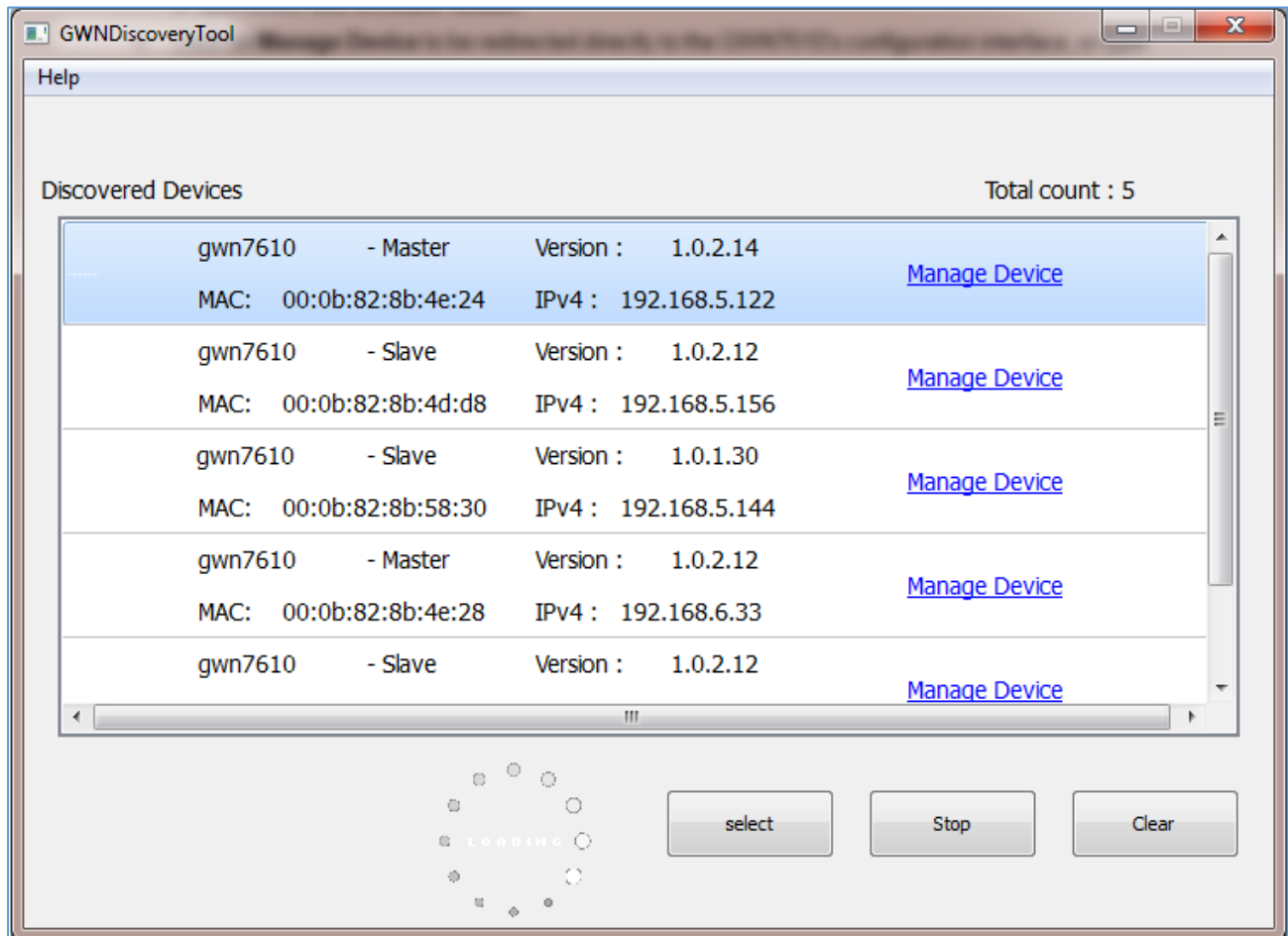

Figure 11: GWN Discovery Tool

Users can access then the GWN7610 using its Web GUI, the following sections will explain how to access and use the Web Interface.

Use the Web GUI

Access Web GUI

The GWN7610 embedded Web server responds to HTTPS GET/POST requests. Embedded HTML pages allow users to configure the device through a Web browser such as Microsoft IE, Mozilla Firefox, Google Chrome etc.





Figure 12: GWN7610 Web GUI Login Page

To access the Web GUI:

1. Make sure to use a computer connected to the same local network as the GWN7610.
2. Ensure the device is properly powered up.
3. Open a Web browser on the computer and type in the URL using the MAC address as shown in [Discover the GWN7610](#) or the IP address using the following format:

https://IP_Address

4. Enter the login and password to access the Web interface.

Notes:

- There are two user-level passwords for the login page:

User Level	User	Default Password	Web Pages Allowed
End User Level	user	123	Only following pages are allowed: <ul style="list-style-type: none"> • Overview • Access Points • Clients • System Settings → About
Administrator Level	admin	admin	Browse all pages

- At first boot or after factory reset, users will be asked to change the default administrator password before accessing GWN7610 Web interface. The new password field is case sensitive with a maximum length of 32 characters. Using strong password including letters, digits and special characters is recommended for better security.



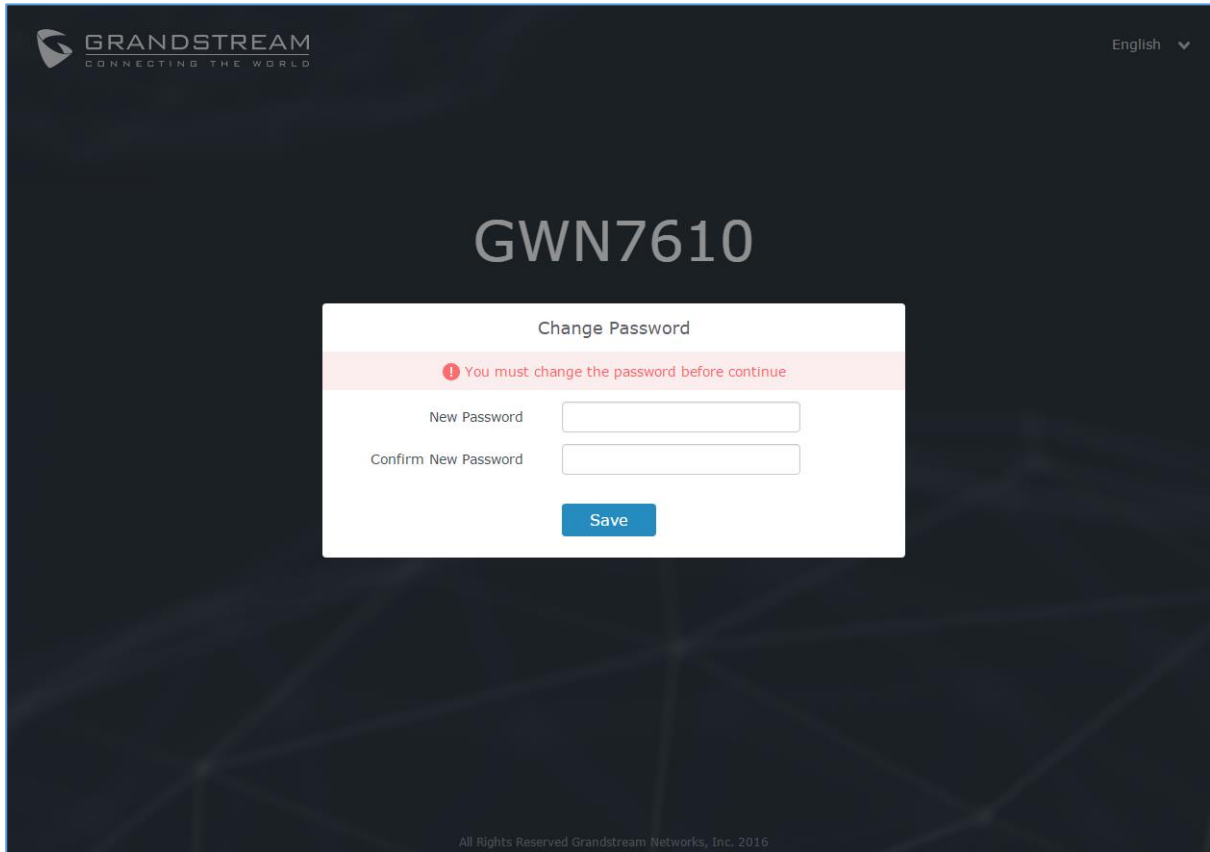

Figure 13: Change Password on first boot

Web GUI Languages

Currently the GWN7610 series Web GUI supports **English** and **Simplified Chinese**.

Users can select the displayed language at the upper right of the Web GUI either before or after logging in.



Figure 14: GWN7610 Web GUI Language – Login page



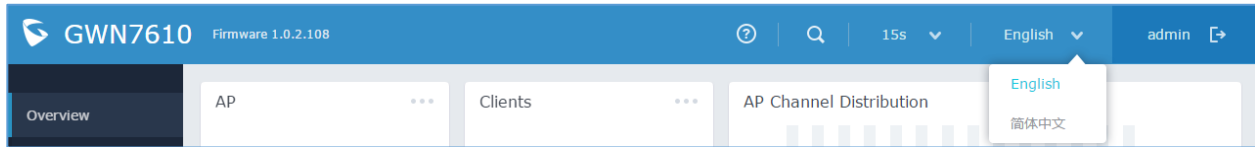

Figure 15: GWN7610 Web GUI Language

Overview Page

Overview is the first page shown after successful login to the GWN7610's Web Interface. Overview page provides an overall view of the GWN7610's information presented in a Dashboard style for easy monitoring.

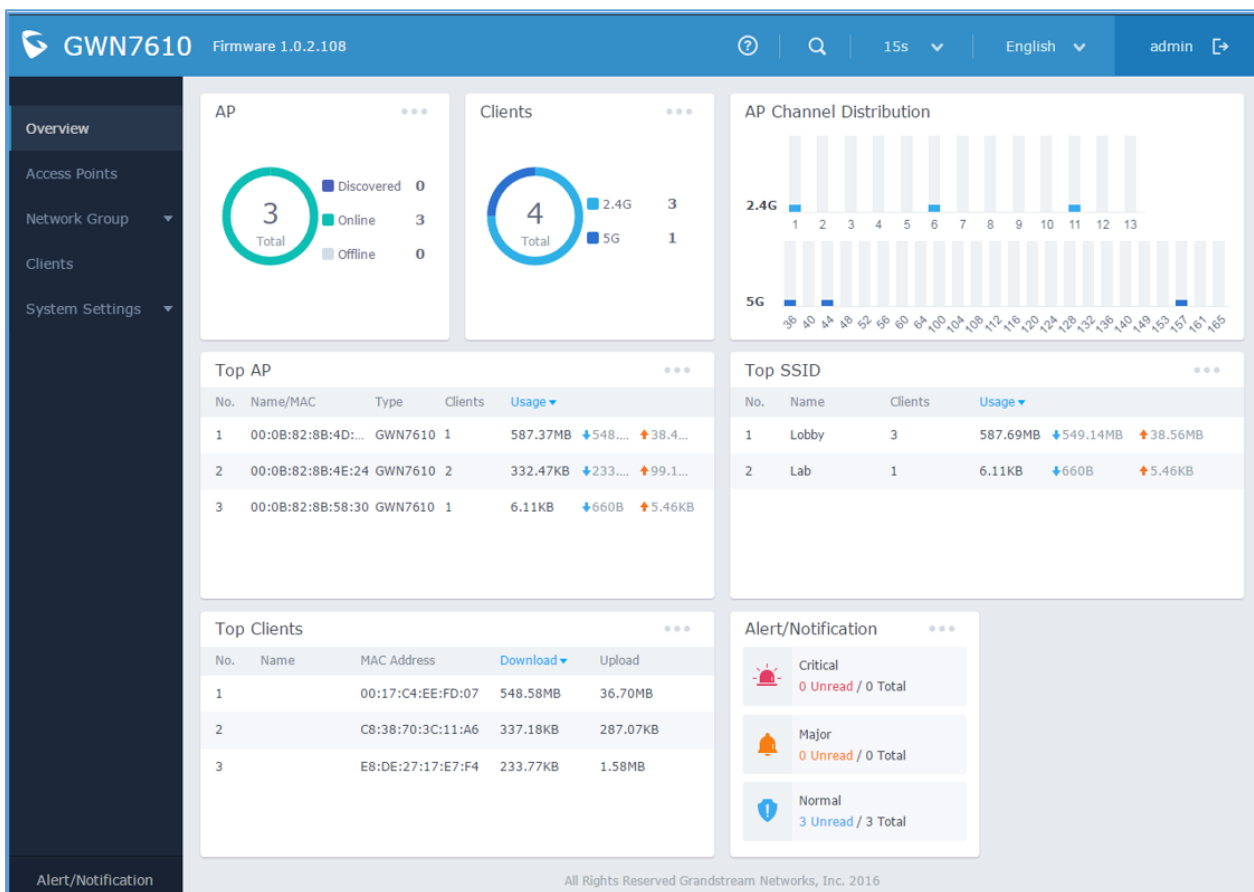









Figure 16: Overview Page

Users can quickly see the status of the GWN7610 for different items, please refer to the following table for each item:



Table 5: Overview

AP	Shows the number of Access Points that are Discovered, Paired(Online) and Offline. Users may click on  to go to Access Points page for basic and advanced configuration options for the APs
Clients	Shows the total number of connected clients, and a count for clients connected to each Channel. Users may click on  to go to Clients page for more options.
AP Channel Distribution	Shows the Channel used for all APs that are paired with this Access Point.
Top AP	Shows the Top APs list, users may assort the list by number of clients connected to each AP or data usage combining upload and download. Users may click on  to go to Access Points page for basic and advanced configuration options for the APs.
Top SSID	Shows the Top SSIDs list, users may assort the list by number of clients connected to each SSID or data usage combining upload and download. Users may click on  to go to Network Group page for more options.
Top Clients	Shows the Top Clients list, users may assort the list of clients by their upload or download. Users may click on  to go to Clients page for more options.
Alert/Notification	Shows 3 types of Alert/Notifications: Critical, Major and Normal. Users can click  to pop up the list of Alert and Notifications.

Note that Overview page in addition to other tabs can be updated each 15s, 1min ,2min and 5min or Never by clicking  in the upper bar menu (Default is 15s).

Save and Apply Changes

When clicking on "Save" button after configuring or changing any option on the Web GUI pages. A message mentioning the number of changes will appear on the upper menu.

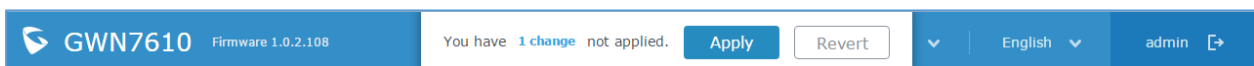

Figure 17: Apply Changes

Click on  button to apply changes, or  to undo the changes.

USING GWN7610 AS STANDALONE ACCESS POINT

The GWN7610 can be used in Standalone mode, where it can act as Master Access Point Controller or in Slave mode and managed by another GWN76xxMaster.

This section will describe how to use and configure the GWN7610 in standalone mode.

Connect to GWN7610 Default Wi-Fi Network

GWN7610 can be used as standalone access point out of box, or after factory reset with Wi-Fi enabled by default.

After powering the GWN7610 and connecting it to the network, GWN7610 will broadcast a default SSID based on its MAC address **GWN[MAC's last 6 digits]** and a random password.

Note that GWN7610's default SSID and password information are printed on the MAC tag of the unit as shown on the below figure.

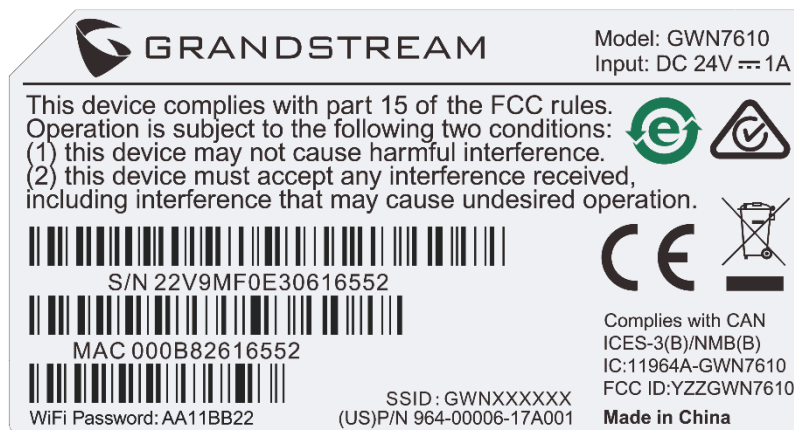

Figure 18: MAC Tag Label



USING GWN7610 AS MASTER ACCESS POINT CONTROLLER

Master Mode allows a GWN7610 to act as an Access Point Controller managing other GWN7610 access points. This will allow users adding other access points under one controller and managing them in an easy and a centralized way.

Master/Slave mode is helpful with large installations that need more coverage area zones with the same controller.

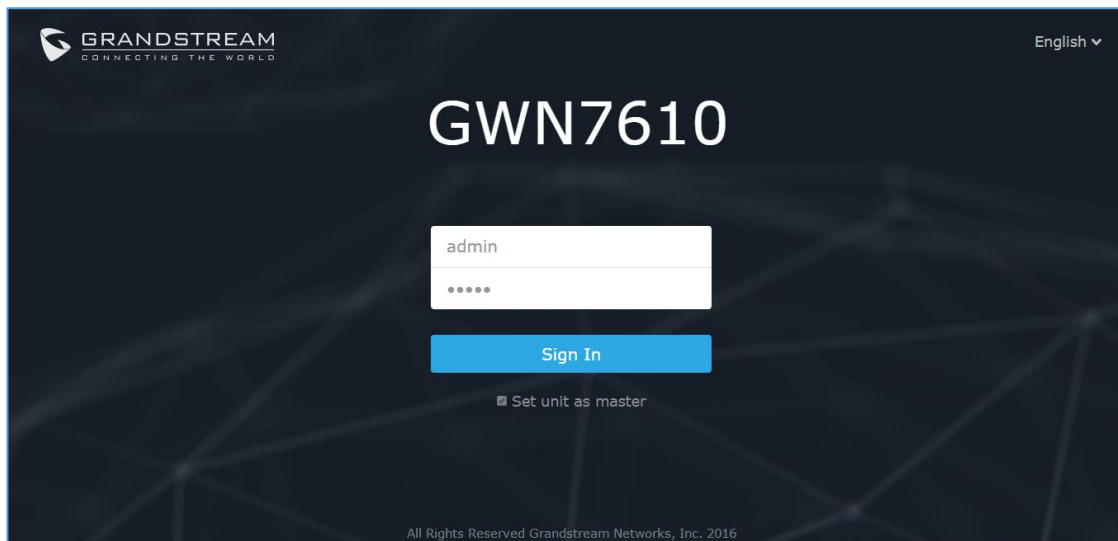

Figure 19: Login Page

At factory reset, “**Set unit as Master**” will be checked by default, click on “**Sign In**” after typing the admin’s username and password.

 **Warning:**

“**Set unit as Master**” option will forbid the GWN7610 Access Point from being paired by other Master GWN7610, and can only act as a Master Access point controller.

Users will need to perform a factory reset to the GWN7610, or unpair it from the initial GWN7610 to make it open to Master Access Point mode again.

Login Page

After login, users can use the Setup Wizard tool to go through the configuration setup, or exit and configure it manually. Setup Wizard can be accessed anytime by clicking on  while on the Web interface.



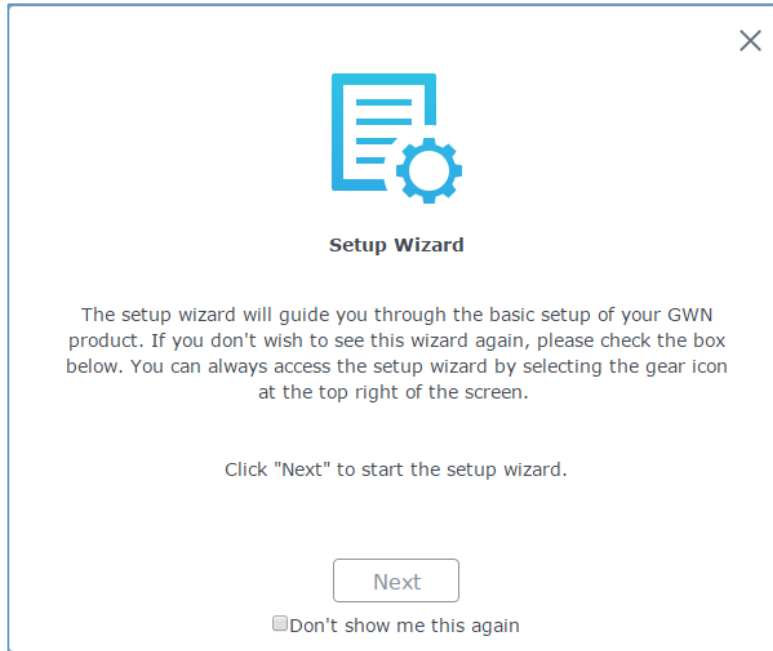

Figure 20: Setup Wizard

Discover and Pair Other GWN7610 Access Point

To Pair a GWN7610 access point connected to the same Network as the GWN7610 follow the below steps:

1. Connect to the GWN7610 Web GUI as Master and go to **Access Points**.

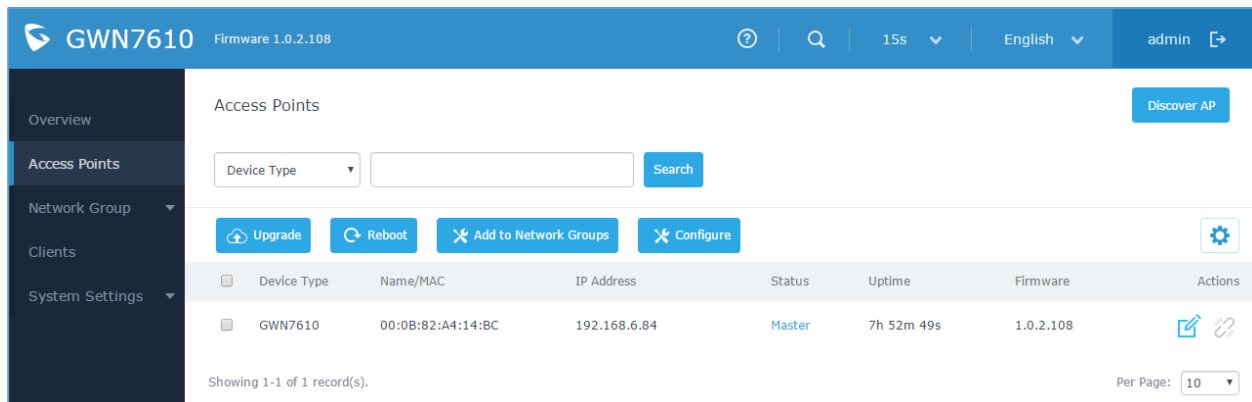



Figure 21: Discover AP

2. Click on **Discover AP** to discover access points within GWN7610's Network, the following page will appear.





Discovered Devices				
Device Type	MAC	IP Address	Firmware	Actions
GWN7610	00:0B:82:8B:4D:D8	192.168.5.156	1.0.2.108	
GWN7610	00:0B:82:8B:58:30	192.168.5.140	1.0.2.108	

Showing 1-2 of 2 record(s). Per Page: 10 ▾

Figure 22: Discovered Devices

Note: Discovered Slave Aps with lower firmware than the master AP will be highlighted in red bold to remind the users to upgrade their AP, more details refer to [Controller Protocol Security Enhancement]

- Click on Pair  under Actions, to pair the discovered Access Point as Slave with the GWN7610 acting as Master
- The paired GWN7610 will appear Online, users can click on  to unpair it.

<input type="checkbox"/>	GWN7610	00:0B:82:A4:14:BC	192.168.6.84	Master	8h 2m 22s	1.0.2.108	 
--------------------------	---------	-------------------	--------------	--------	-----------	-----------	---

Figure 23: GWN7610 online

- Users can click on  next to Master or paired access point to check device configuration for its status, users connected to it and configuration. Refer to below table for Device Configuration tabs.

Table 6: Device Configuration

Field	Description
Status	Shows the device's status information such as Firmware version, IP Address, Link Speed, Uptime, and Users count via different Radio channels.
Users	Shows the users connected to the GWN7610 access point.
Configuration	<ul style="list-style-type: none"> Device Name: Set GWN7610's name to identify it along with its MAC address. Fixed IP: Used to set a static IP for the GWN7610, if checked users will need to set the following: <ul style="list-style-type: none"> -IPv4 Address: Enter the IPv4 address to be set as static for the device



-*IPv4 Subnet Mask*: Enter the Subnet Mask.

-*IPv4 Gateway*: Enter the Network Gateway's IPv4 Address.

-*Preferred IPv4 DNS*: Enter the Primary IPv4 DNS.

-*Alternate IPv4 DNS*: Enter the Alternate IPv4 DNS.

- **Frequency**: Set the GWN7610's frequency, it can be either 2.4GHz, 5GHz or Dual-band.
- **Enable Band Steering**: When Frequency is set to Dual-Band, users can check this option to enable Band Steering on the Access Point, this will help redirecting clients to a radio band accordingly for efficient use and to benefit from the maximum throughput supported by the client.
- **Mode**: Choose the mode for the frequency band, 802.11n/g/b for 2.4GHz and 802.11ac for 5GHz.
- **Channel Width**: Choose the Channel Width, note that wide channel will give better speed/throughput, and narrow channel will have less interference. 20MHz is suggested in very high-density environment.
- **40MHz Channel Location**: Configure the 40MHz channel location when using 20MHz/40MHz in Channel Width, users can set it to be "Secondary Below Primary", "Primary Below Secondary" or "Auto".
- **Channel**: Select "Auto" or a specific channel. Default is "Auto". Note that the proposed channels depend on **Country** Settings under **System Settings**→**Maintenance**.
- **Enable Short Guard Interval**: Check to activate this option to increase throughput.
- **Active Spatial Streams**: Choose active spatial stream. Available options: "Auto", "1 stream", "2 streams" and "3 streams".
- **Radio Power**: Set the Radio Power depending on desired cell size to be broadcasted, three options are available: "Low", "Medium" or "High". Default is "High".
- **Reboot Device**: Reboot the access point. (Available for Slave Access Points only)
- **Upgrade Device Firmware**: Upgrade the access point's firmware (Available for Slave Access Points only)



Note:

If a GWN7610 is not being paired or the pair icon is grey color, make sure that it is not being paired with another GWN7610 Access Point acting as Master Controller, if yes, users will need to unpair it first, or reset it to factory default settings to make it available for pairing by other GWN7610 Access Point Controller.

Controller Protocol Security Enhancement

Controller protocol security enhancement is important for secured provision from Master to Slave. So once a master with 1.0.2.108 found a slave with an older firmware version, it will disable the slave's Wi-Fi and show the slave's firmware version in RED BOLD to remind user to upgrade the slave as shown on figure below.

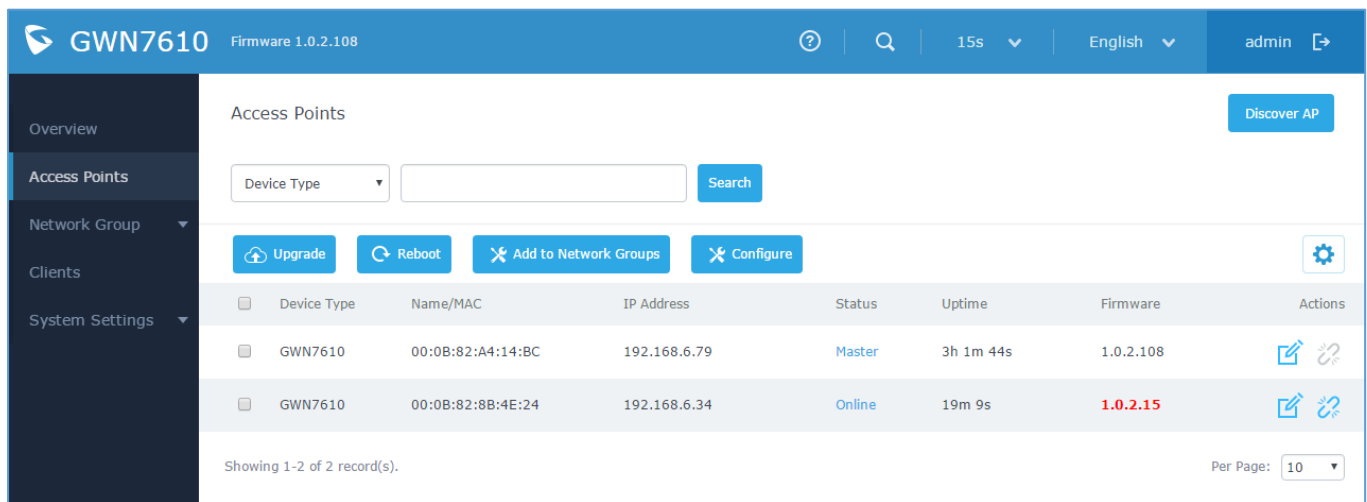

The screenshot shows the GWN7610 web interface. The top navigation bar includes the GWN7610 logo, the current firmware version (1.0.2.108), a search icon, a refresh icon (15s), a language dropdown (English), and an admin user profile. The left sidebar contains navigation options: Overview, Access Points (selected), Network Group, Clients, and System Settings. The main content area is titled 'Access Points' and features a 'Discover AP' button, a search bar, and action buttons for Upgrade, Reboot, Add to Network Groups, and Configure. Below these is a table of Access Points:

Device Type	Name/MAC	IP Address	Status	Uptime	Firmware	Actions
GWN7610	00:0B:82:A4:14:BC	192.168.6.79	Master	3h 1m 44s	1.0.2.108	[Edit] [Unpair]
GWN7610	00:0B:82:8B:4E:24	192.168.6.34	Online	19m 9s	1.0.2.15	[Edit] [Unpair]

At the bottom of the table, it says 'Showing 1-2 of 2 record(s)' and 'Per Page: 10'.

Figure 24: Controller Protocol Security Enhancement



NETWORK GROUPS

When using GWN7610 as Master Access Point, users can create different Network groups and adding GWN7610 Slave Access Points.

Log in as Master to the GWN7610 WebGUI and go to **Network Group**→**Network Group**.

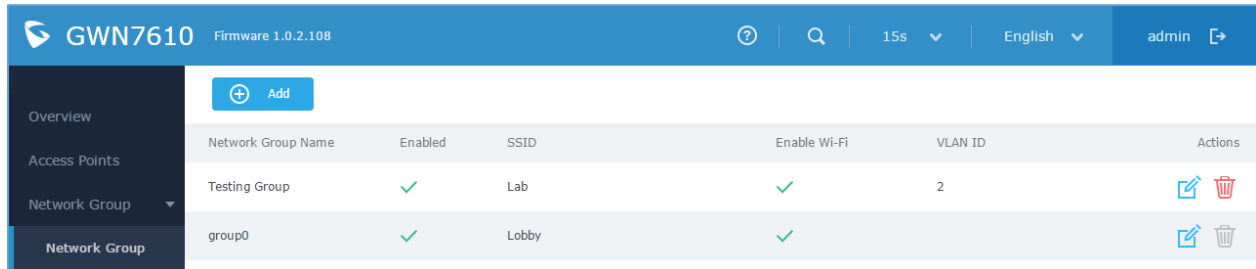

Network Group Name	Enabled	SSID	Enable Wi-Fi	VLAN ID	Actions
Testing Group	✓	Lab	✓	2	
group0	✓	Lobby	✓		

Figure 25: Network Group

The GWN7610 will have a default network group named group0, click on to edit it, or click on to add a new network group.

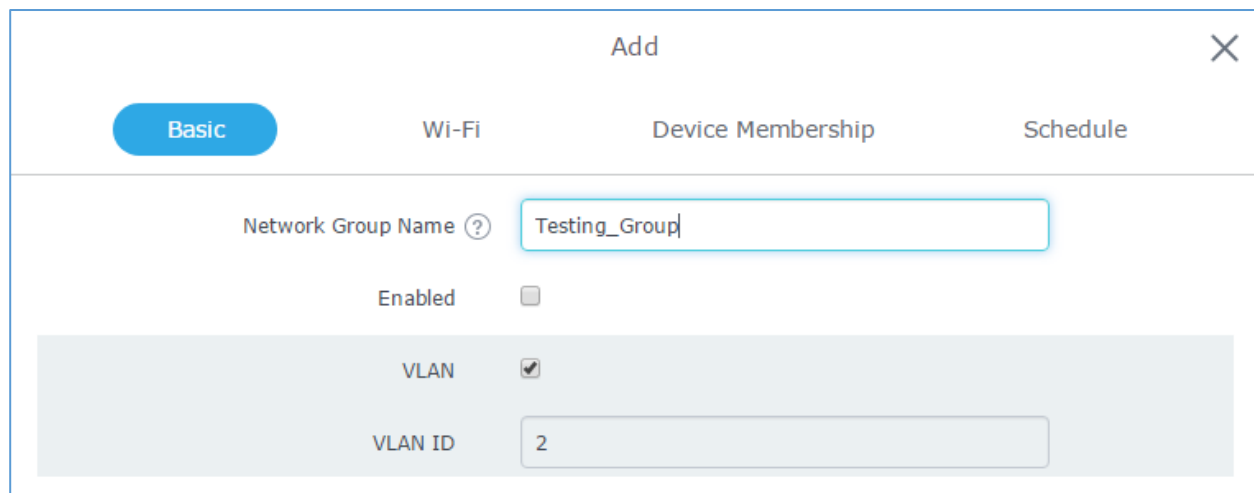

Add ✕

Basic
Wi-Fi
Device Membership
Schedule

Network Group Name ?

Enabled

VLAN

VLAN ID

Figure 26: Add a New Network Group

When editing or adding a new network group, users will have three tabs to configure:

- **Basic:** Used to name the network group, and set a VLAN ID if adding a new network group
- **Wi-Fi:** Please refer to the below table for Wi-Fi tab options

Table 7: Wi-Fi

Filed	Description
Enable Wi-Fi	Check to enable Wi-Fi for the network group.
SSID	Set or modify the SSID name.



SSID Hidden	<p>Select to hide SSID. SSID will not be visible when scanning for Wi-Fi, to connect a device to hidden SSID, users need to specify SSID name and authentication password manually.</p>
Security Mode	<p>Set the security mode for encryption, 5 options are available:</p> <ul style="list-style-type: none"> • WEP 64-bit: Using a static WEP key. The characters can only be 0-9 or A-F with a length of 10, or printable ASCII characters with a length of 5. • WEP 128-bit: Using a static WEP key. The characters can only be 0-9 or A-F with a length of 26, or printable ASCII characters with a length of 13. • WPA/WPA2: Using “PSK” or “802.1x” as WPA Key Mode, with “AES” or “AES/TKIP” Encryption Type. • WPA2: Using “PSK” or “802.1x” as WPA Key Mode, with “AES” or “AES/TKIP” Encryption Type. Recommended configuration for authentication. • Open: No password is required. Users will be connected without authentication. Not recommended for security reasons.
Use MAC Filtering	<p>Choose Blacklist/Whitelist to specify MAC addresses to be excluded/included from connecting to the zone’s Wi-Fi. Default is Disabled.</p>
Client Isolation	<p>Client isolation feature blocks any TCP/IP connection between connected clients to GWN7610’s Wi-Fi access point. Client isolation can be helpful to increase security for Guest networks/Public Wi-Fi.</p> <p>Three modes are available:</p> <ul style="list-style-type: none"> • Internet Mode: Wireless clients will be allowed to access only the internet services and they cannot access any of the management services, either on the router nor the access points GWN7610. • Gateway MAC Mode: Wireless clients can only communicate with the gateway, the communication between clients is blocked and they cannot access any of the management services on the GWN7610 access points. • Radio Mode: Wireless clients can access to the internet services, GWN7xxx router and the access points GWN7610 but they cannot communicate with each other. <p>The default value is “Disabled”.</p>



Gateway MAC Address	<p>This field is required when Client Isolation is set to “Gateway MAC”, so users will not lose access to the Network (usually Internet).</p> <p>Type in the default LAN Gateway’s MAC address (router’s MAC address for instance) in hexadecimal separated by “:”.</p> <p>Example: 00:0B:82:8B:4D:D8</p>
RSSI Enabled	<p>Check to enable RSSI function, this will lead the AP to disconnect users below the configured threshold in Minimum RSSI (dBm).</p>
Minimum RSSI (dBm)	<p>Enter the minimum RSSI value in dBm. If the signal value is lower than the configured minimum value, the client will be disconnected. The input range is from “-94” or “-1”.</p>

- **Device Membership:** Used to add or remove paired access points to the network group.

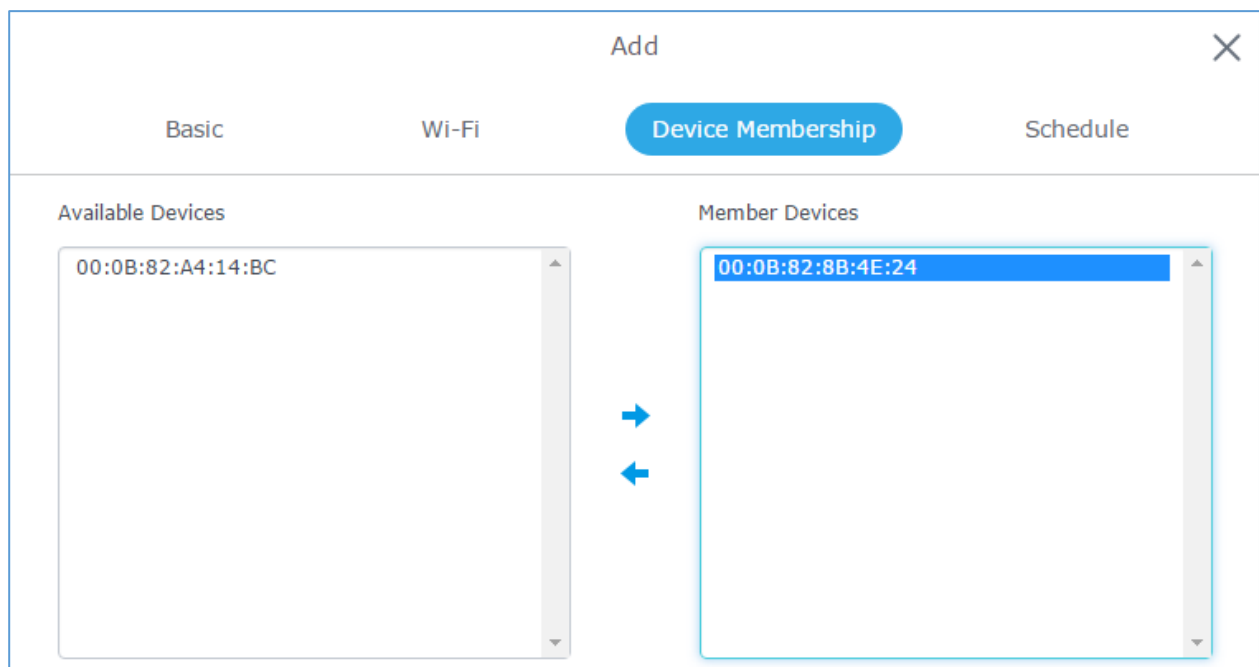

Figure 27: Device Membership

Click on  to add the GWN7610 to the network group, or click on  to remove it.

- **Schedule:** Used to schedule the times when the Wi-Fi is ON or OFF.

In the example below the Wi-Fi is scheduled to be active Monday starting from 8:00 AM until 5:00 PM.

Note: The hour field is in 24 format (from 0 to 23). Valid range for minutes is 0-59.



Add ✕

Basic
Wi-Fi
Device Membership
Schedule

Enable Wireless Schedule

Sunday

Monday

Schedule Start Time :

Schedule End Time :

Tuesday

Wednesday

Thursday

Friday

Saturday

Save
Cancel

Figure 28: Wi-Fi Schedule

Note:

The schedule feature is based on SSID and not network group, meaning that you can schedule the broadcasting of different SSID on different periods of the day.

Users can also add a device to a Network Group from Access Points Page:

- Select the desired AP to add to a Network Group and click on



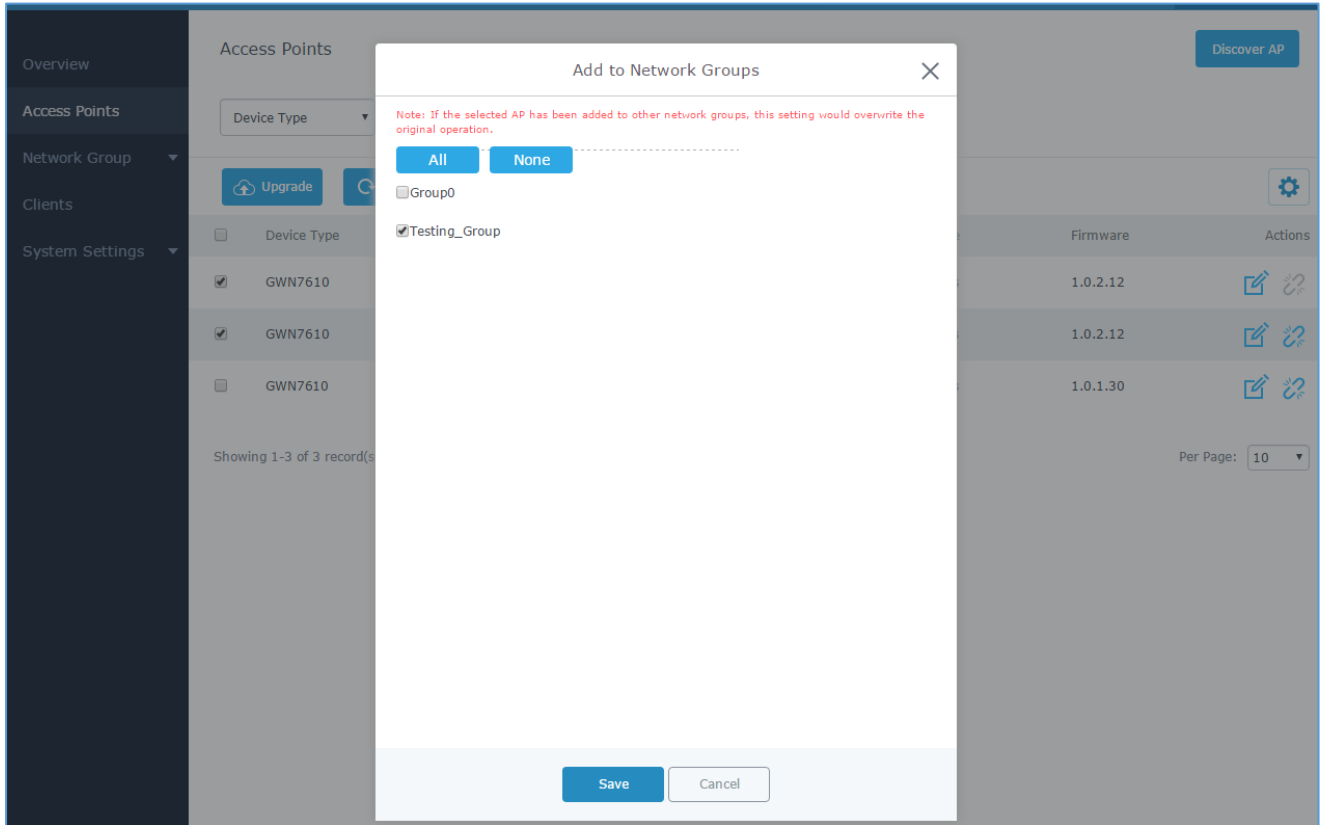

Figure 29: Add AP to Network Group from Access Points Page

- Check to select the desired Network, on which the selected APs will be added, as shown in the above figure.

Create an SSID under a Network Group

Under Network Group Page, click to edit a network group or create a new network group and go to Wi-Fi tab.



Add ✕

Basic
Wi-Fi
Device Membership

Enable Wi-Fi

SSID (?)

SSID Hidden

Security Mode

WPA Key Mode

WPA Encryption Type

WPA Pre-Shared Key (?) (eye icon)

Use MAC Filtering

Client Isolation (?)

Enable RSSI (?)

Minimum RSSI (dBm) (?)

Save
Cancel

Figure 30: Create an SSID

Refer to [Table 7: Wi-Fi] for Wi-Fi options.

Additional SSID under Same Network Group

Users can also create an additional SSID under the same group. To create an additional SSID go to **Network Group**→**Additional SSID**.



Add ✕

Enable Additional SSID

SSID ?

Network Group Membership
▼

SSID Hidden

Security Mode
▼

WPA Key Mode
▼

WPA Encryption Type
▼

WPA Pre-Shared Key ?
👁

Use MAC Filtering
▼

Client Isolation

Enable RSSI ?

Minimum RSSI (dBm) ?

Figure 31: Additional SSID

Select one of the available network groups from **Network Group Membership** dropdown menu, this will create an additional SSID with the same Device Membership configured when creating the main network group.

SSID	Enabled	Network Group	Hidden	Security Mode	MAC Filtering	Client Isolati...	RSSI	Actions
Additional_SSID	✓	group0	✗	WPA2	Disabled	✗	✗	

Figure 32: Additional SSID Created

Click on to delete the additional SSID, or to edit it.



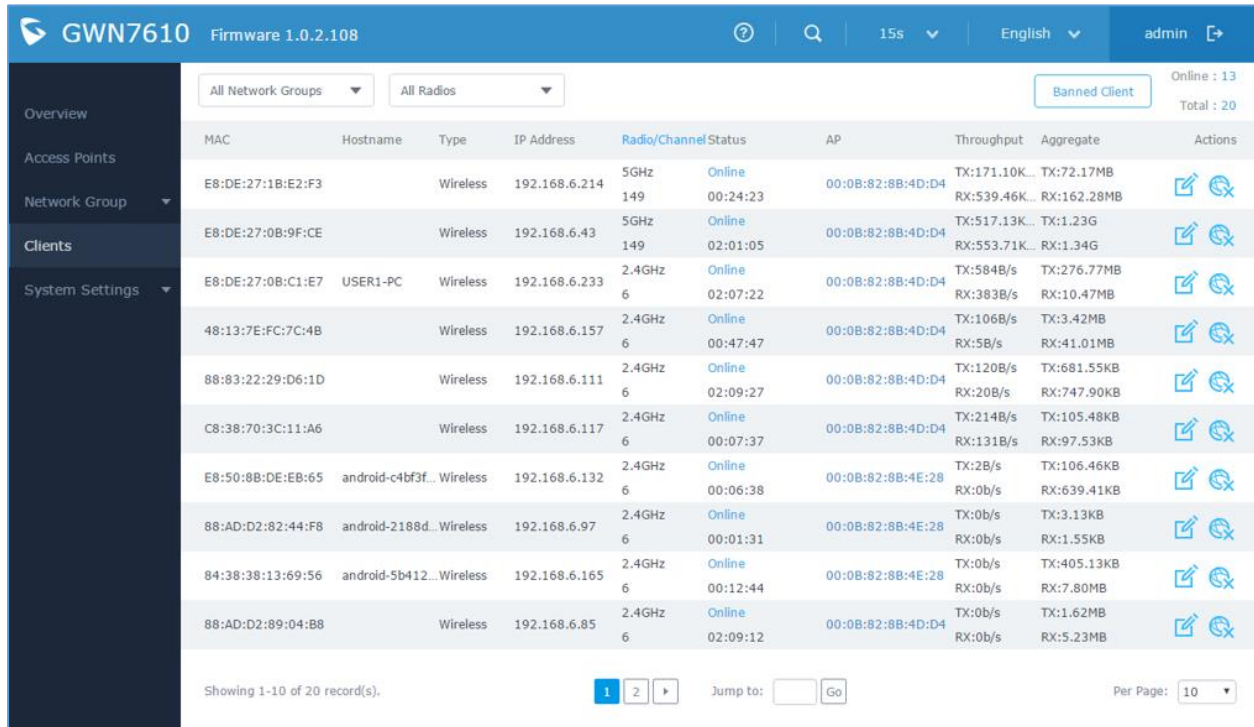

CLIENTS CONFIGURATION

Users can access clients list connected to GWN7610 zone from GWN7610 **Web GUI**→**Clients** to perform different actions to wireless clients.



MAC	Hostname	Type	IP Address	Radio/Channel	Status	AP	Throughput	Aggregate	Actions
E8:DE:27:1B:E2:F3		Wireless	192.168.6.214	5GHz 149	Online 00:24:23	00:0B:82:8B:4D:D4	Tx:171.10K... Rx:539.46K...	Tx:72.17MB Rx:162.28MB	
E8:DE:27:0B:9F:CE		Wireless	192.168.6.43	5GHz 149	Online 02:01:05	00:0B:82:8B:4D:D4	Tx:517.13K... Rx:553.71K...	Tx:1.23G Rx:1.34G	
E8:DE:27:0B:C1:E7	USER1-PC	Wireless	192.168.6.233	2.4GHz 6	Online 02:07:22	00:0B:82:8B:4D:D4	Tx:584B/s Rx:383B/s	Tx:276.77MB Rx:10.47MB	
48:13:7E:FC:7C:4B		Wireless	192.168.6.157	2.4GHz 6	Online 00:47:47	00:0B:82:8B:4D:D4	Tx:106B/s Rx:5B/s	Tx:3.42MB Rx:41.01MB	
88:83:22:29:D6:1D		Wireless	192.168.6.111	2.4GHz 6	Online 02:09:27	00:0B:82:8B:4D:D4	Tx:120B/s Rx:20B/s	Tx:681.55KB Rx:747.90KB	
C8:38:70:3C:11:A6		Wireless	192.168.6.117	2.4GHz 6	Online 00:07:37	00:0B:82:8B:4D:D4	Tx:214B/s Rx:131B/s	Tx:105.48KB Rx:97.53KB	
E8:50:8B:DE:E8:65	android-c4bf3f...	Wireless	192.168.6.132	2.4GHz 6	Online 00:06:38	00:0B:82:8B:4E:28	Tx:2B/s Rx:0b/s	Tx:106.46KB Rx:639.41KB	
88:AD:D2:82:44:F8	android-2188d...	Wireless	192.168.6.97	2.4GHz 6	Online 00:01:31	00:0B:82:8B:4E:28	Tx:0b/s Rx:0b/s	Tx:3.13KB Rx:1.55KB	
84:38:38:13:69:56	android-5b412...	Wireless	192.168.6.165	2.4GHz 6	Online 00:12:44	00:0B:82:8B:4E:28	Tx:0b/s Rx:0b/s	Tx:405.13KB Rx:7.80MB	
88:AD:D2:89:04:B8		Wireless	192.168.6.85	2.4GHz 6	Online 02:09:12	00:0B:82:8B:4D:D4	Tx:0b/s Rx:0b/s	Tx:1.62MB Rx:5.23MB	

Figure 33: Clients

- Click on  under Actions to check a client's status and modify basic settings such as Device's Name.
- Click on  to block a client's MAC address from connecting to the zone's network group.
- Click on **Banned Client** to add or remove a client from banned client list.

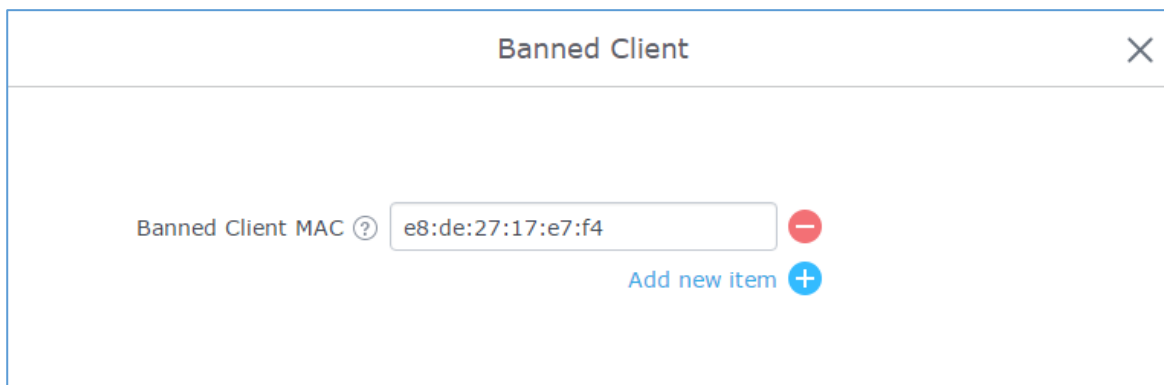

Banned Client ✕

Banned Client MAC ? -

Add new item +

Figure 34: Ban/Unban Client



LED SCHEDULE

GWN7610 Access Points series support also the LED schedule feature. This feature is used to set the timing when the LEDs are ON and when they will go OFF at customer’s convenience.

This can be useful for example when the LEDs become disturbing during some periods of the day, this way with the LED scheduler, you can set the timing so that the LEDs are off at night after specific hours and maintain the Wi-Fi service for other clients without shutting down the AP.

To configure LED schedule, on the GWN7610 WebGUI navigate to “System Settings → LEDs”.

Following options are available:

Table 8: LED Schedule settings

Option	Description
LEDs Always off	Turn off completely the LEDs.
Schedule Start Hour	Configure the hour when LEDs will be automatically turned on.
Schedule Start Minute	Configure the minute when LEDs will be automatically turned on.
Schedule Stop Hour	Configure the hour when LEDs will be automatically turned off.
Schedule Stop Minute	Configure the minute when LEDs will be automatically turned off.
Schedule weekdays list	Choose the days for which you want to schedule the LEDs.

Following example set the LEDs to be turned on from 8am till 8pm every day.



GWN7610 Firmware 1.0.2.108

admin

LEDs

LEDs Always Off

Schedule Start Hour

Schedule Start Minute

Schedule Stop Hour

Schedule Stop Minute

Schedule Weekdays List of Weekdays

Sunday

Monday

Tuesday

Wednesday

Thursday

Friday

Saturday

Figure 35: LEDs Schedule



CAPTIVE PORTAL

Captive Portal feature on GWN7610 Access Points allows to define a Landing Page (Web page) that will be displayed on Wi-Fi clients' browsers when attempting to access Internet. Once connected to GWN7610 AP, Wi-Fi clients will be forced to view and interact with that landing page before Internet access is granted. The Captive Portal feature can be configured from the GWN7610 Web page, by navigating to "System Settings→Captive Portal".

The page contains three tabs: **Basic**, **Files** and **Clients**.



Basic Configuration Page

The basic configuration page contains options to enable/disable the captive portal feature, related firewall rules and timeout settings. The following table describes all the settings on this page:



Table 9: Basic Configuration Page

Field	Description
Enable	Check this option to enable/disable the captive portal feature. If disabled, configuration and uploaded files will not be lost. If enabled, Wi-Fi users will be redirected to defined landing page before accessing Internet.
Max Clients	Specifies the maximum number of clients that can connect to the network via the captive portal feature.
Client Idle Timeout (min)	Configures the time of inactivity after which the client will be automatically de-authenticated. Valid range between 10 to 240. Default is 30 min.
Client Force Timeout (min)	Configures the time after which the client will be automatically de-authenticated without considering his status (active or idle). Valid range between 10 to 240. Default is 60 min.
Authenticated User Rules	Defines and manages rules for traffic from Router to Authenticated Users. <u>Default/Typical Authenticated User Rules:</u> <ul style="list-style-type: none"> • Allow TCP port 22 This rule allows traffic over TCP on port 22 (SSH) • Allow TCP port 53



	<p>This rule allows traffic over TCP on port 53 (DNS)</p> <ul style="list-style-type: none"> • Allow UDP port 53 <p>This rule allows traffic over UDP on port 53 (DNS)</p> <ul style="list-style-type: none"> • Allow TCP port 80 <p>This rule allows traffic over TCP on port 80 (HTTP)</p> <ul style="list-style-type: none"> • Allow TCP port 443 <p>This rule allows traffic over TCP on port 443 (HTTPS)</p> <p>Notes:</p> <ul style="list-style-type: none"> ▪ Not defined rules for specific ports are denied by default. ▪ These rules are applied in order. <p><u>Rule syntax is the following:</u></p> <p>Allow/Deny TCP/UDP port <port number>.</p> <p><u>Examples:</u></p> <p>The following rules will allow FTP access and deny TFTP.</p> <p><i>allow TCP port 20</i></p> <p><i>allow TCP port 21</i></p> <p><i>deny UDP port 69</i></p> <p>Note: Users can Click on  to delete an existing rule or  to add a new rule.</p>
<p>User to Router Rules</p>	<p>Defines and manages rules for traffic from Users to Router.</p> <p><u>Default/Typical User to Router Rules:</u></p> <ul style="list-style-type: none"> • Allow TCP port 22 <p>This rule allows traffic over TCP on port 22 (SSH)</p> <ul style="list-style-type: none"> • Allow TCP port 23 <p>This rule allows traffic over TCP on port 23 (TELNET)</p> <ul style="list-style-type: none"> • Allow TCP port 53 <p>This rule allows traffic over TCP on port 53 (DNS)</p> <ul style="list-style-type: none"> • Allow UDP port 53 <p>This rule allows traffic over UDP on port 53 (DNS)</p> <ul style="list-style-type: none"> • Allow UDP port 67 <p>This rule allows traffic over UDP on port 67 (DHCP)</p> <ul style="list-style-type: none"> • Allow TCP port 80 <p>This rule allows traffic over TCP on port 80 (HTTP)</p> <ul style="list-style-type: none"> • Allow TCP port 443



	<p>This rule allows traffic over TCP on port 443 (HTTPS)</p> <p>Notes:</p> <ul style="list-style-type: none"> ▪ Not defined rules for specific ports are denied by default. ▪ These rules are applied in order. <p><u>Rule syntax is the following:</u></p> <p>Allow/Deny TCP/UDP port <port number>.</p> <p>Note: Users can Click on  to delete an existing rule or  to add a new rule.</p>
Network Group	<p>Selects the network group from the drop-down list where authenticated clients will belong to.</p>

Files Configuration Page

Files configuration page allows to view and upload HTML pages and related files (images...).

The captive portal uses **splash.html** as landing page, Wi-Fi clients will be redirected to this page before accessing Internet.

The following figure shows default **splash.html** page

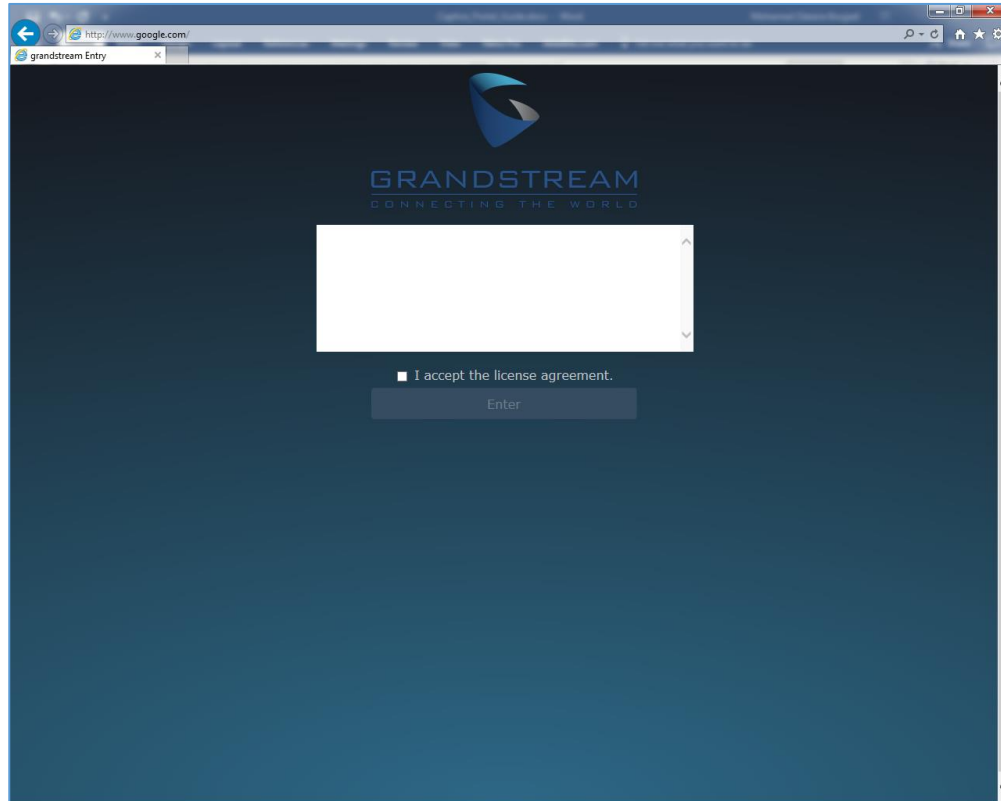

Figure 36: Default “splash.html” page



The following figure shows default files used for Captive Portal:

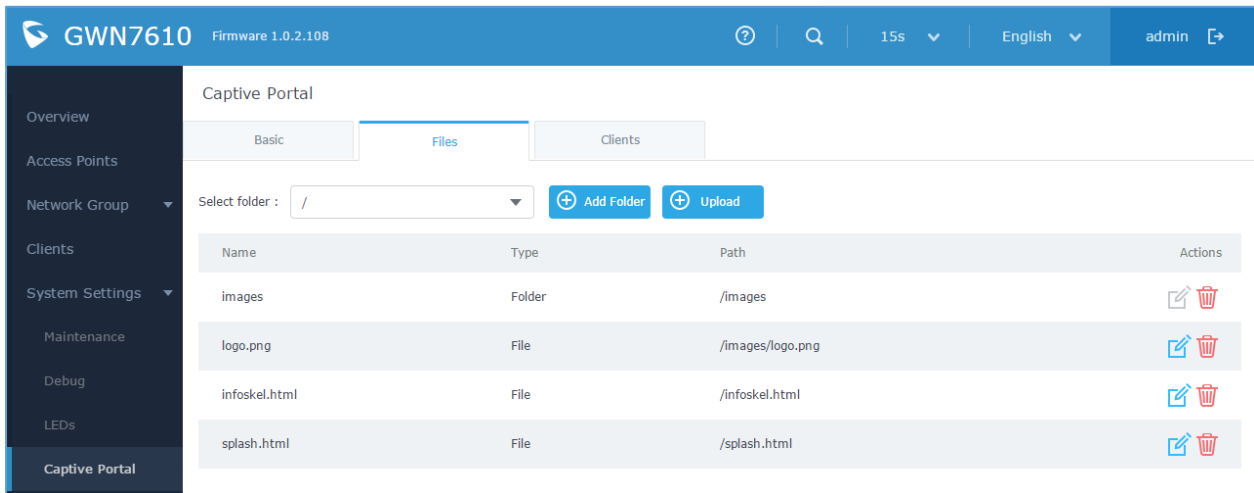



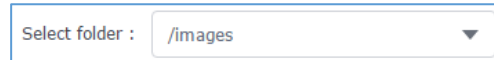

Figure 37: Files Settings Page

- Click  to upload a new Web page.
- Click  to add a new folder.
- Click  to upload files to the selected folder.

- Folder can be selected from the dropdown list



Clients Page

Clients page lists MAC addresses of authenticated devices using captive portal.

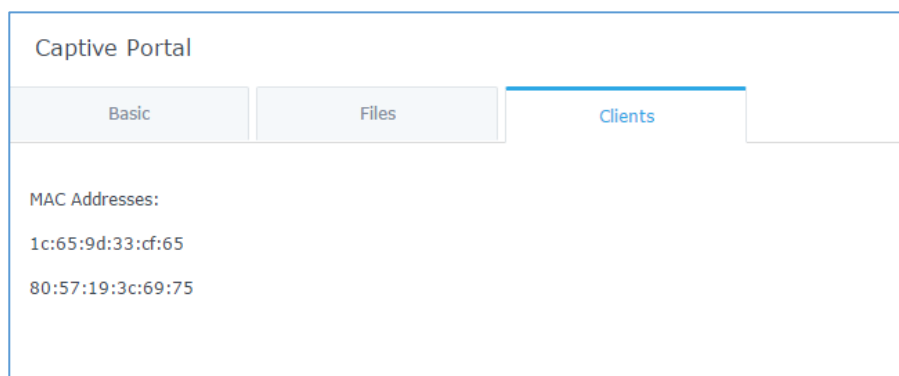

Figure 38: Client Web Page



SYSTEM SETTINGS

Maintenance

Refer to the following tables for Maintenance page options.

Basic

Basic page allows Country and Time configuration.

Table 10: Basic

Field	Description
Country	Select the country from the drop-down list. This can affect the number of channels depending on the country standards.
Time Zone	Configure time zone for the GWN7610. Please reboot the device to take effect.
NTP Server	Configure the IP address or URL of the NTP server, the device will obtain the date and time from the configured server.
Date Display Format	Change the Date Display Format, three options are possible YYYY/MM/DD, MM/DD/YYYY and DD/MM/YYYY

Upgrade

The Upgrade Web page allows upgrade related configuration.

Table 11: Upgrade

Field	Description
Authenticate Config File	Authenticate configuration file before acceptance. Default is disabled.
XML Config File Password	Enter the password for encrypting the XML configuration file using OpenSSL. The password is used to decrypt the XML configuration file if it is encrypted via OpenSSL.
Upgrade Via	Specify uploading method for firmware and configuration. 3 options are available: HTTP, HTTPS and TFTP.
Firmware Server	Configure the IP address or URL for the firmware upgrade server.
Config Server	Configure the IP address or URL for the configuration file server.
Check/Download New Firmware at Boot Update on Boot	Choose whether to enable or disable automatic upgrade and provisioning after reboot. Default is disabled.
Automatic Upgrade Check Interval(m)	Specify the time to check for firmware upgrade (in minutes).



Reboot	Click on Reboot button to reboot the device
Download Configuration	Click on Download to download the device's configuration file.
Upload Configuration	Click on Upload a device's configuration file.
Upgrade Now	Click on Upgrade, to launch firmware/config file provisioning. Please make sure to Save and Apply changes before clicking on Upgrade.
Factory Reset	Click on Reset to restore the GWN7610 to factory default settings

Access

The Access Web page provide configuration for admin and user password.

Table 12: Access

Field	Description
Current Administrator Password	Enter the current administrator password
New Administrator Password	Change the current password. This field is case sensitive with a maximum length of 32 characters.
Confirm New Administrator Password	Enter the new administrator password one more time to confirm.
User Password	Configure the password for user-level Web GUI access. This field is case sensitive with a maximum length of 32 characters.
User Password Confirmation	Enter the new User password again to confirm.

Syslog

The syslog Web page provides configuration settings for syslog.

Table 13: Syslog

Field	Description
Syslog Server	Enter the IP address or URL of Syslog server. Please reboot the GWN7610 to take effect.
Syslog Level	Select the level of Syslog, 5 levels are available: None , Debug , Info , Warning and Error . Please reboot the GWN7610 to take effect.

Debug

GWN7610 offers many features for managing and monitoring connected clients to network groups, as well as debugging and troubleshooting.



Capture

This section is used to generate packet trace captures from network groups interfaces which will help to sniff packets within the network group for troubleshooting purpose or monitoring...



Users will need to plug a USB device to one of the USB ports on the back of the GWN7610.

To access Capture page, go to **Maintenance**→**Debug**→**Capture**

Click on  to start capturing on a certain device plugged to the USB port.

Click on  to stop the capture.

Click on  to show the captured files on a chosen device, users could check the capture files

details, click on  to delete all files, click on  next to a capture file to download it on a local folder, or click on  to delete it.

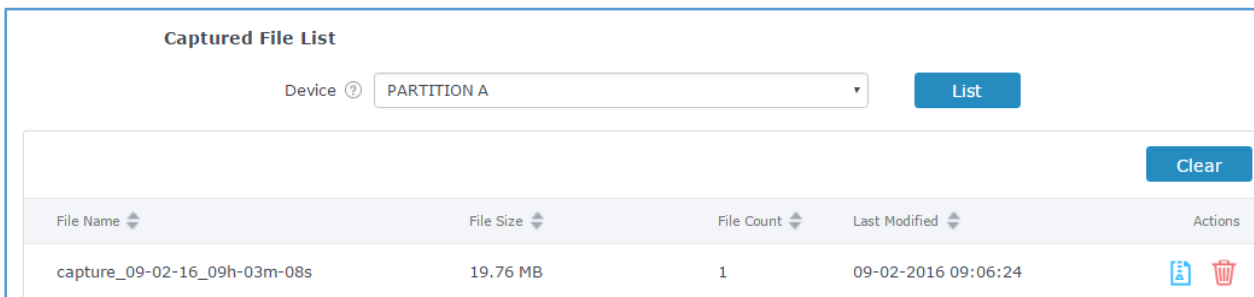



File Name	File Size	File Count	Last Modified	Actions
capture_09-02-16_09h-03m-08s	19.76 MB	1	09-02-2016 09:06:24	 

Figure 39: Capture Files

The below table will show different fields used on debug page

Table 14: Debug

Filed	Description
File Name	Enter the name of the capture file that will be generated.
Interface	Choose a network group as Interface.
Device	Choose a device plugged to USB port to save the capture once started.
File Size	Set a File size that the capture will not exceed (Optional field)
Rotate Count	Set a value for rotating captures (Optional Field)
Direction	Choose if you want to get all traffic or only outgoing or incoming to the choses interface.



Source Port	Set the Source Port to filter capture traffic coming from the defined source port.
Destination Port	Set the Destination Port to filter capture traffic coming from the defined port.
Source IP	Set the Source IP to filter capture traffic coming from the defined source IP.
Destination IP	Set the Destination IP to filter capture traffic coming from the defined destination IP.
Protocol	Choose ALL or a specific protocol to capture (IP, ARP, RARP, TCP, UDP, ICMP, IPv6)

Core Files

The Core Files Web page displays core dumps generated when the GWN7610 crash, this is helpful for troubleshooting purposes, if any core dump found on this page please help to contact our support team for further investigation using following link: <https://helpdesk.grandstream.com/>

Ping/Traceroute

Ping and Traceroute are useful debugging tools to verify reachability with other clients across the network. The GWN7610 offers both Ping and Traceroute tools for IPv4 and IPv6 protocols. To use these tools, go to GWN7610 **WebGUI**→**System Settings**→**Debug** and click on **Ping/Traceroute**.

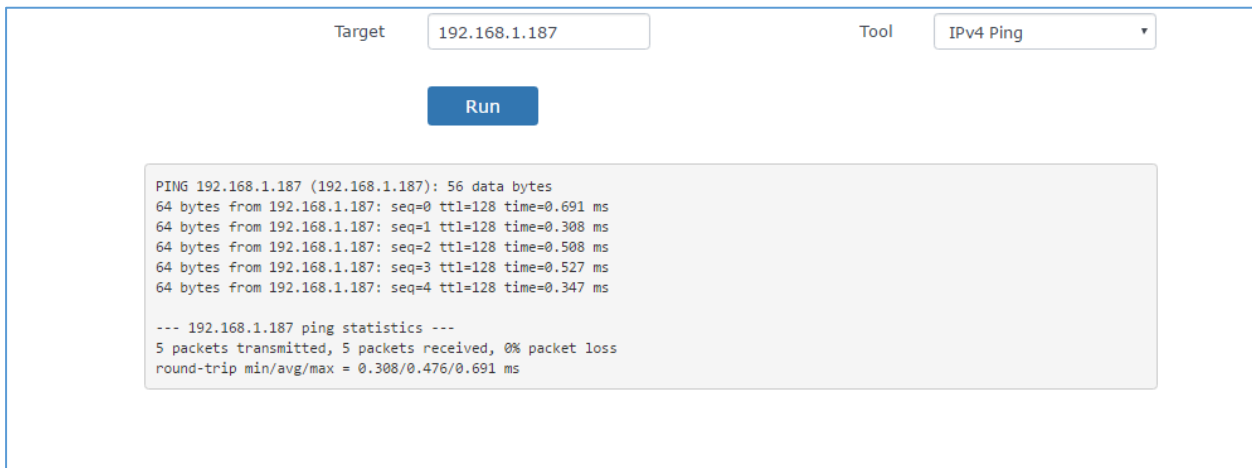

Target: 192.168.1.187 Tool: IPv4 Ping

Run

```

PING 192.168.1.187 (192.168.1.187): 56 data bytes
64 bytes from 192.168.1.187: seq=0 ttl=128 time=0.691 ms
64 bytes from 192.168.1.187: seq=1 ttl=128 time=0.308 ms
64 bytes from 192.168.1.187: seq=2 ttl=128 time=0.508 ms
64 bytes from 192.168.1.187: seq=3 ttl=128 time=0.527 ms
64 bytes from 192.168.1.187: seq=4 ttl=128 time=0.347 ms

--- 192.168.1.187 ping statistics ---
5 packets transmitted, 5 packets received, 0% packet loss
round-trip min/avg/max = 0.308/0.476/0.691 ms
  
```

Figure 40: IP Ping

- Next to **Tool** choose from the dropdown menu:
 - IPv4 Ping for an IPv4 Ping test to Target
 - IPv6 Ping for an IPv6 Ping test to Target
 - IPv4 Traceroute for an IPv4 Traceroute to Target
 - IPv6 Traceroute for an IPv6 Traceroute to Target
- Type in the destination's IP address/domain name in **Target** field.
- Click on **Run**.



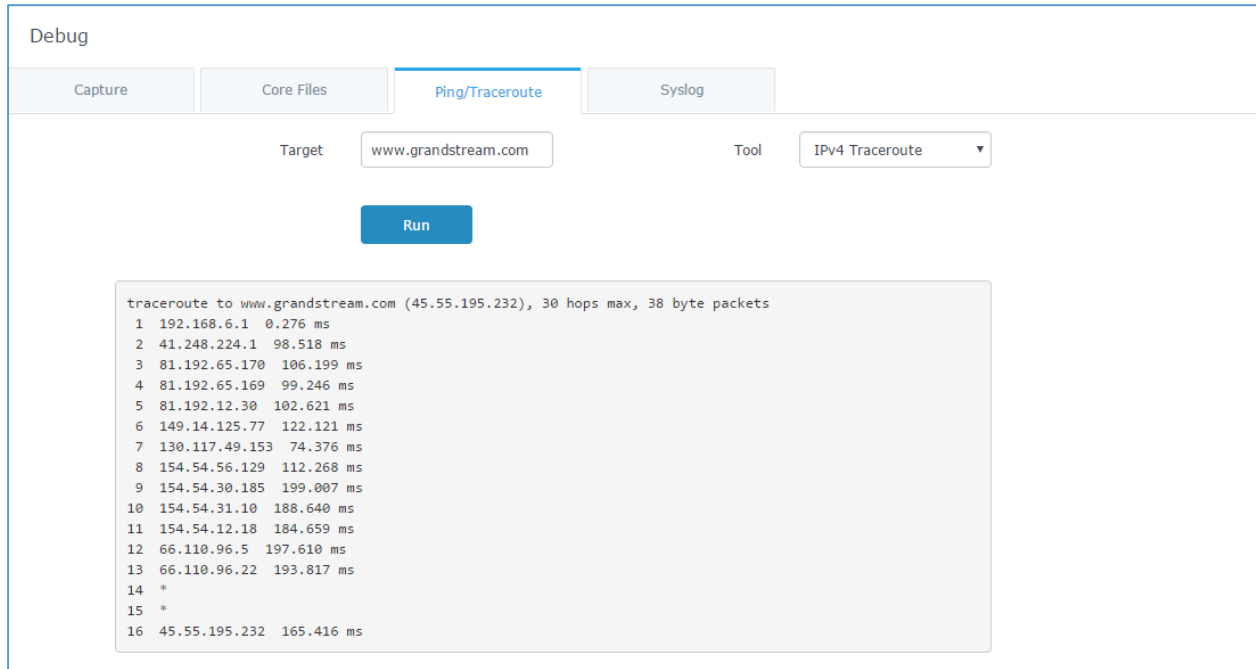

Figure 41: Traceroute

Syslog

The syslog Web page displays logs generated by the GWN7610 for troubleshooting purpose as shown in figure below.

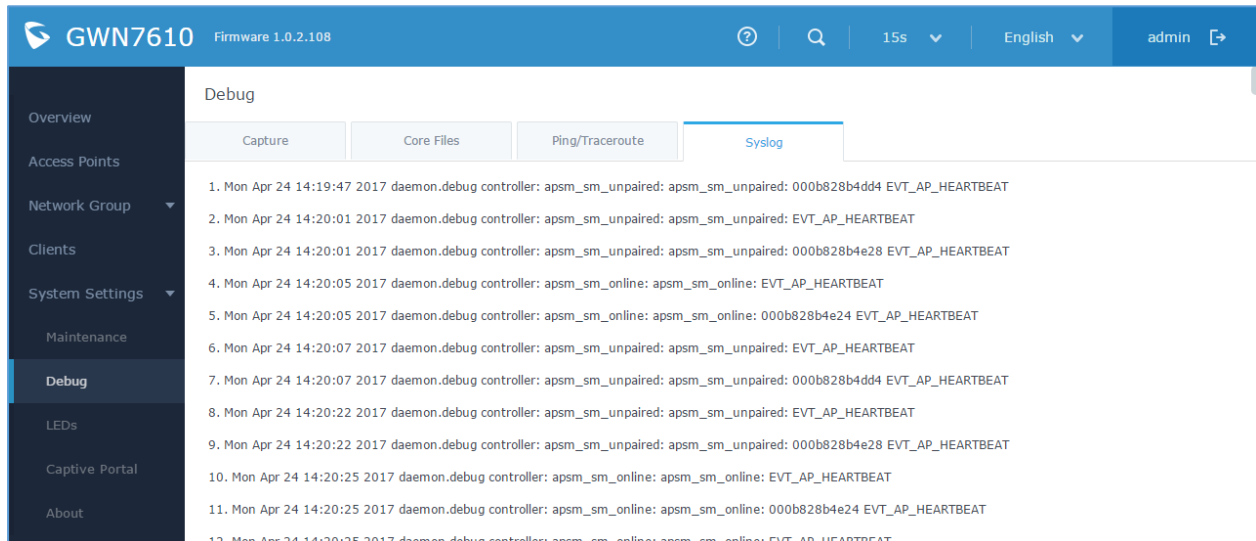

Figure 42: Syslog



UPGRADING AND PROVISIONING

Upgrading Firmware

The GWN7610 can be upgraded to a new firmware version remotely or locally. This section describes how to upgrade your GWN7610.

Upgrading via WEB GUI

The GWN7610 can be upgraded via TFTP/HTTP/HTTPS by configuring the URL/IP Address for the TFTP/HTTP/HTTPS server and selecting a download method. Configure a valid URL for TFTP, HTTP or HTTPS; the server name can be FQDN or IP address.

Examples of valid URLs:

firmware.grandstream.com/BETA
 192.168.5.87

The upgrading configuration can be accessed via **Web GUI**→**System Settings**→**Maintenance**→**Upgrade**.

Table 15: Network Upgrade Configuration

Field	Description
Upgrade Via	Allow users to choose the firmware upgrade method: TFTP, HTTP or HTTPS.
Firmware Server	Define the server path for the firmware server.
Check Update on Boot	Allows the device to check if there is a firmware from the configured firmware server at boot.
Automatic Upgrade check interval(m)	Set the value for automatic upgrade check in minutes.
Upgrade Now	Click on  button to begin the upgrade. Note that the device will reboot after downloading the firmware.

Upgrading Slave Access Points

When the GWN7610 is being paired as slave using another GWN7610 Access Point acting as Controller, users can upgrade their paired access points from the GWN7610 Master Controller.

To upgrade a slave access point, log in to the GWN7610 acting as Master Controller and go to **Access Points**.



Access Points [Discover AP](#)



Device Type [Search](#)

[Upgrade](#)
[Reboot](#)
[Add to Network Groups](#)

<input type="checkbox"/>	Device Type	Name/MAC	IP Address	Status	Uptime	Firmware	Actions
<input type="checkbox"/>	GWN7610	00:0B:82:8B:4E:24	192.168.5.122	Master	5m 5s	1.0.2.108	
<input checked="" type="checkbox"/>	GWN7610	00:0B:82:8B:4D:D8	192.168.5.156	Online	2h 25m 15s	1.0.2.13	
<input checked="" type="checkbox"/>	GWN7610	00:0B:82:8B:58:30	192.168.5.140	Online	2h 25m 17s	1.0.2.108	

Showing 1-3 of 3 record(s). Per Page:

Figure 43: Access Points

Make sure that firmware server path is set correctly under Maintenance, check the desired APs to upgrade, and click on  to upgrade the selected paired access points, or click on  next to the paired device to access its configuration page, and click on  to upgrade the device.



Device Configuration ✕

Status
Users
Configuration

Frequency Dual-Band ▼

Enable Band Steering

2.4GHz

5GHz

Mode ? 802.11n ▼

802.11ac ▼

Channel Width ? 20MHz ▼

80MHz ▼

40MHz Channel Location ? Auto ▼

Channel Auto ▼

Auto ▼

Enable Short Guard Interval

Active Spatial Streams ? Auto ▼

Auto ▼

Radio Power ? High ▼

High ▼

Reboot Device Reboot

Upgrade Device Firmware ? Upgrade

Save
Cancel

Figure 44: Device Configuration

The status of the device will show Upgrading, wait until it finishes and reboots, then it will appear online again.

GWN7610	00:0B:82:8B:4D:D4	192.168.6.20	Upgrading	1d 22h 48m 29s	1.0.2.108	
---------	-------------------	--------------	-----------	----------------	-----------	--

Figure 45: GWN7610 Upgrading

⚠ Notes:

- Please do not interrupt or power cycle the GWN7610 during upgrading process.
 - The Master Access Point needs to be upgraded from **Web GUI→System Settings→Maintenance**. It cannot be upgraded from Access Points page like the Paired Access Points.
-



Service providers should maintain their own firmware upgrade servers. For users who do not have TFTP/HTTP/HTTPS server, some free windows version TFTP servers are available for download from http://www.solarwinds.com/products/freetools/free_tftp_server.aspx
<http://tftpd32.jounin.net>

Please check our Website at <http://www.grandstream.com/support/firmware> for latest firmware.

Instructions for local firmware upgrade via TFTP:

1. Unzip the firmware files and put all of them in the root directory of the TFTP server;
2. Connect the PC running the TFTP server and the GWN7610 to the same LAN segment;
3. Launch the TFTP server and go to the File menu→Configure→Security to change the TFTP server's default setting from "Receive Only" to "Transmit Only" for the firmware upgrade;
4. Start the TFTP server and configure the TFTP server in the GWN7610 Web configuration interface;
5. Configure the Firmware Server to the IP address of the PC;
6. Update the changes and reboot the GWN7610.

End users can also choose to download a free HTTP server from <http://httpd.apache.org/> or use Microsoft IIS Web server.

Provisioning and backup

The GWN7610 configuration can be backed up locally or via network. The backup file will be used to restore the configuration on GWN7610 when necessary.

Download Configuration

Users can download the GWN7610 configuration for restore purpose under **Web GUI→System Settings→Maintenance**

Click on  to download locally the configuration file.

Upload Configuration

Users can upload configuration file to the GWN7610 under **Web GUI→System Settings→Maintenance**

Click on  to browse for the configuration to upload.

Please note that the GWN7610 will reboot after the configuration file is restored successfully.



Configuration Server (Pending)

Users can download and provision the GWN7610 by putting the config file on a TFTP/HTTP or HTTPS server, and set Config Server to the TFTP/HTTP or HTTPS server used for the GWN7610 to be provisioned with that config server file.

Reset and reboot

Users could perform a reboot and reset the device to factory functions under **Web GUI**→**System**

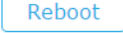
Settings→**Maintenance** by clicking on  button.

 Will restore all the GWN7610 itself to factory settings.



EXPERIENCING THE GWN7610 WIRELESS ACCESS POINT

Please visit our Website: <http://www.grandstream.com> to receive the most up- to-date updates on firmware releases, additional features, FAQs, documentation and news on new products.

We encourage you to browse our [product related documentation](#), [FAQs](#) and [User and Developer Forum](#) for answers to your general questions. If you have purchased our products through a Grandstream Certified Partner or Reseller, please contact them directly for immediate support.

Our technical support staff is trained and ready to answer all your questions. Contact a technical support member or [submit a trouble ticket online](#) to receive in-depth support.

Thank you again for purchasing Grandstream GWN7610 Wireless Access Point, it will be sure to bring convenience and color to both your business and personal life

